

vtech®

User's manual
www.vtechphones.com



Model: DS6472-6

 **Bluetooth®**



DECT 6.0

Congratulations

on purchasing your new VTech product. Before using this telephone, please read **Important safety instructions** on page 120 of this manual.

This manual has all the feature operations and troubleshooting necessary to install and operate your new VTech telephone. Please review this manual thoroughly to ensure proper installation and operation of this innovative and feature rich VTech product. For support, shopping, and everything new at VTech, visit our website at www.vtechphones.com. In Canada, please visit www.vtechcanada.com.



Telephones identified with this logo have reduced noise and interference when used with most T-coil equipped hearing aids and cochlear implants. The TIA-1083 Compliant Logo is a trademark of the Telecommunications Industry Association. Used under license.

Register online to get an additional 3-month warranty!

Visit www.vtechphones.com.



Registration

Register your product online for enhanced warranty support.



Product news

Learn about the latest VTech products.

The *Bluetooth*[®] word mark and logos are registered trademarks owned by Bluetooth SIG, Inc. and any use of such marks by VTech Holdings Limited is under license. VTech Holdings Limited is a member of Bluetooth SIG, Inc. Other trademarks and trade names are those of their respective owners.

Table of contents

Getting started	1
Parts checklist	1
Installation	2
Telephone base and charger installation	3
Handset battery installation	4
Handset battery charging.....	5
Headset charger installation	6
Power on the headset	6
Headset charging	6
Headset battery	7
Earbud installation	8
Ear hook installation.....	9
Head band installation	12
Installation options	14
Tabletop to wall mount installation	14
Wall mount to tabletop installation.....	15
Telephone base layout	16
Handset layout	17
Headset layout	20
Handset main menu	21
Bluetooth®	23
Introducing Bluetooth	23
Glossary of terms	24
Bluetooth setup	25
Add a cell phone	25
Add a headset	27
Auto connection	28
Connecting devices.....	29
Review the device list.....	29
Connect/Disconnect an active device	29
Remove a device.....	30
Rename a device	31
Replace an active device	32
Bluetooth connection from idle mode	32
Download directory	33
Interruption to directory download.....	35

View the directory download information	35
Change PIN.....	36
Telephone settings	37
Handset settings	37
Ringers	37
Ringer volume (handset).....	37
Ringer volume (headset)	37
Ringer tone.....	38
Set date and time	39
Settings	40
LCD language	40
Voice language.....	40
Display alerts.....	41
CID time synchronization	44
Rename handsets	44
Key tone	45
Dial mode	45
Caller ID announce	46
Website	47
Home area code.....	47
Cell area code	48
Telephone base settings	49
Answering system settings	49
Telephone operation	50
Make, answer or end a home call	50
Call waiting on the home line	51
Make, answer or end a cell call	52
Call waiting on the cell line.....	52
Answer a cell call while on a home call.....	53
Cell phone voicemail.....	53
Answer a home call while on a cell call	53
Conference home and cell calls	54
Using the home and cell lines together	54
Handset speakerphone.....	55
Volume control	55

Table of contents

Silence the ringer	55
Mute	55
Temporary tone dialing	56
Hold	56
Handset/headset locator	56
Equalizer	57
Transfer a call	57
Chain dialing	58
Redial list	59
Review the redial list	59
Dial a redial entry	59
Save a redial entry to the directory	60
Delete a redial entry	60
Multiple handset use	61
Share an outside call	61
Intercom	61
Answer an incoming call during an intercom call	62
Transfer a call using intercom	63
Push-to-talk (PTT)	64
PTT on/off	64
PTT to a single handset	65
PTT to multiple handsets	66
Answer a PTT call	67
Change a one-to-one PTT to intercom call	67
End a PTT call	68
Answer an incoming call during a PTT call	68
Make an outgoing call during a PTT call	68
About the directory	69
Create a new entry in the home directory	70
Review the directory	71
3-character alphabetical search	71
Dial a directory entry	72
Edit a directory entry	72
Edit the type of a directory entry	73
Delete a directory entry	73

Remove a downloaded directory	73
Speed dial	74
Assign a speed dial slot	74
Reassign a speed dial slot	74
Dial a speed dial entry	74
Delete a speed dial entry	75
Caller ID	76
About caller ID	76
Information about caller ID with call waiting	76
Caller ID history	77
Memory match	77
Review the caller ID log	78
View dialing options	79
Dial a caller ID log entry	79
Save a caller ID log entry to the directory	80
Delete from the caller ID log	81
Caller ID log display screen messages	81
Answering system settings ...	82
Answer on/off	82
Announcement	83
Play your announcement	83
Record your own announcement	83
Delete your announcement	84
Answering system setup	85
Call screening	85
Number of rings	86
Remote access code	87
Message alert tone	88
Recording time	88
Answering system operation... 	89
Answering system and voicemail indicators	89
Using the answering system and voicemail together	89
Message capacity	90
Voice prompts	90

Table of contents

Call screening	90
Call intercept	90
Temporarily turning off the message alert tone	91
Message playback	91
Delete all old messages	93
Record and play memos	93
Message window displays	94
Remote access	95
Appendix	96
Display screen messages	96
Handset and telephone base indicators	101
Headset indicators	103
Expand your telephone system...	104
Add and register a handset	104
Add and register a headset	105
Deregister handsets/headsets...	106
Troubleshooting.....	107
Important safety instructions.....	120
Battery	121
Precautions for users of implanted cardiac pacemakers.....	121
Operating range	121
Maintenance.....	121
About cordless telephones	122
The RBRC® seal.....	122
FCC, ACTA and IC regulations ..	123
California Energy Commission battery charging testing instructions	125
For C-UL compliance only	126
Limited warranty	129
Technical specifications	131
Index.....	132

Getting started

Parts checklist

Your telephone contains the following items. Save your sales receipt and original packaging in the event warranty service is necessary.



Quick start guide



Bluetooth quick start guide

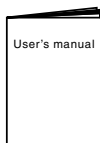

User's manual

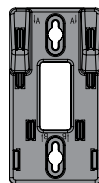

Wall mount bracket



Cordless headset with an earbud attached

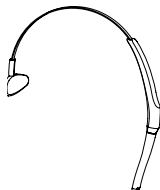

Head band



Ear hooks (3)



Additional earbuds (3)



Ear pad

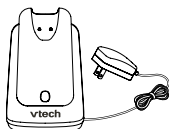

Headset charger with power adapter installed



Battery compartment covers (5)



Batteries (5)



Telephone line cord

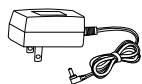

Telephone base power adapter

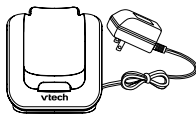

Handset chargers with power adapters installed (4)

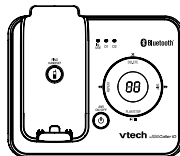

Telephone base



Handsets (5)

note

- The headset battery is not replaceable.
- To purchase a replacement battery or power adapter, visit our website at www.vtechphones.com or call 1 (800) 595-9511. In Canada, go to www.vtechcanada.com or dial 1 (800) 267-7377.

Getting started

Installation

Install the telephone base close to a telephone jack and a power outlet not connected to a wall switch. For optimum range and better reception, place the telephone base in a central and open location.

When using a Bluetooth wireless technology enabled cell phone with this telephone, make sure the cell phone is within 15 feet of the telephone base to maintain a reliable connection between the cell phone and telephone base.

This product may be shipped with protective stickers covering the handsets and telephone base displays. Remove them before use.

Avoid placing the telephone base too close to:

- Communication devices such as personal computers, computer routers, television sets, VCRs, wireless routers (wireless broadband, Wi-Fi, or 802.11) or other cordless telephones.
- Excessive heat sources.
- Noise sources such as a window with traffic outside, motors, microwave ovens, refrigerators, or fluorescent lighting.
- Excessive dust sources such as a workshop or garage.
- Excessive moisture.
- Extremely low temperature.
- Mechanical vibration or shock such as on top of a washing machine or work bench.

Getting started

Telephone base and charger installation

Install the telephone base and chargers as shown below.

Make sure that the electrical outlet is not controlled by a wall switch.

If you subscribe to digital subscriber line (DSL) high-speed Internet service through your telephone line, you must install a DSL filter between the telephone line cord and the telephone wall jack. The filter prevents noise and caller ID problems caused by DSL interference. Contact your DSL service provider for more information about DSL filters.

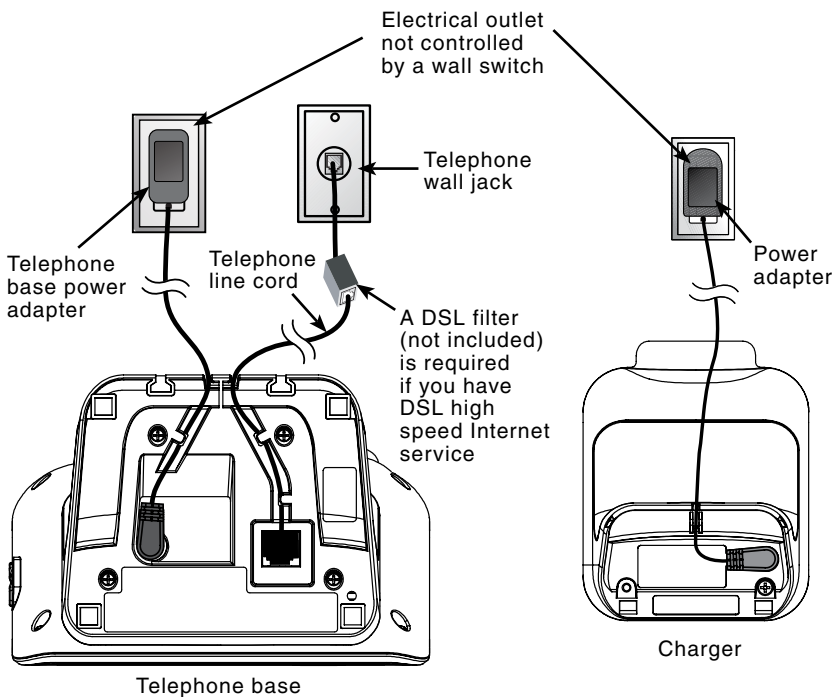

note

- Use only the power adapters supplied with this product. To order a replacement, visit our website at www.vtechphones.com or call 1 (800) 595-9511. In Canada, go to www.vtechcanada.com or dial 1 (800) 267-7377.
- The power adapters are intended to be correctly oriented in a vertical or floor mount position. The prongs are not designed to hold the plug in place if it is plugged into a ceiling, under-the-table or cabinet outlet.

Getting started

Handset battery installation

Install the battery as shown below.

1. Plug the battery connector securely into the socket inside the handset battery compartment, matching the color-coded label.
2. Place the battery with the label **THIS SIDE UP** facing up and the wires inside the battery compartment.
3. Align the cover flat against the battery compartment, then slide it towards the center of the handset until it clicks into place.
4. Charge the handset by placing it in the telephone base or charger. The **CHARGE** light is on when the handset is charging.

①

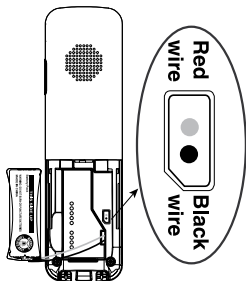

②

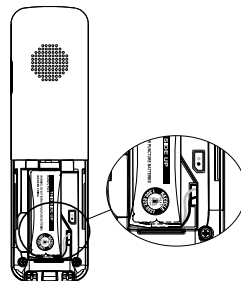

③

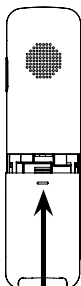

④

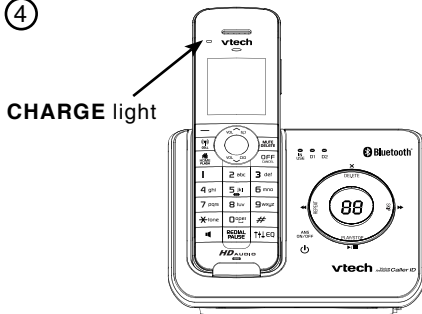

note

- If the handset will not be used for a long time, disconnect and remove the battery to prevent possible leakage.
- To purchase a replacement battery, visit our website at www.vtechphones.com or call 1 (800) 595-9511. In Canada, go to www.vtechcanada.com or dial 1 (800) 267-7377.



Getting started

Handset battery charging

Once you have installed the battery, the handset LCD display indicates the battery status (see the table below).

NOTES

- For best performance, keep the handset in the telephone base or charger when not in use.
- The battery is fully charged after 16 hours of continuous charging.
- If you place the handset in the telephone base or the charger without plugging in the battery, the screen displays **No battery**.

Battery indicators	Battery status	Action
The screen is blank, or shows Place in charger and  flashes.	Battery has no or very little charge. The handset cannot be used.	Charge without interruption until the screen shows HANDSET X (at least 30 minutes).
The screen shows Low battery and  flashes.	Battery has enough charge to be used for a short time.	Charge without interruption until the screen shows HANDSET X (at least 30 minutes).
The screen shows HANDSET X .	Battery is charged.	To keep the battery charged, place it in the telephone base or charger when not in use.

When it is fully charged, you can expect the following performance:

Operation	Operating time
While in handset use (talking*)	Seven hours
While in speakerphone mode (talking*)	Three hours
While not in use (standby**)	Five days

* Operating times vary depending on your actual use and the age of the battery.

** Handset is not charging or in use.

After you install your telephone or power returns following a power outage, the handset will prompt you to set the date and time. For instructions, see **Set date and time** on page 39. To skip setting, press **OFF/CANCEL** or **BACK**.



Getting started

Headset charger installation

Install the headset charger as shown below.

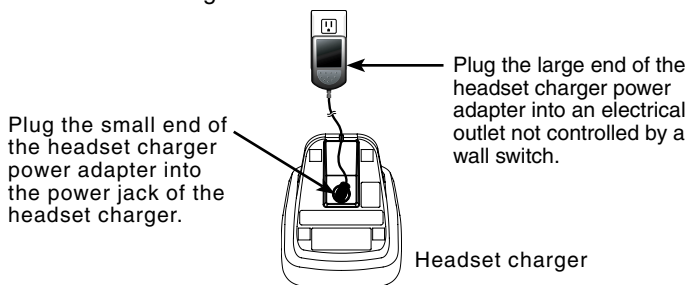

Power on the headset

Power on the headset before use. Place the headset in the headset charger or press and hold ⏻ for two seconds. The ⏻ light flashes three times in blue and you hear three beeps when the headset is being powered on.

note

If the headset will not be used for a long time, press and hold ⏻ for two seconds to power off the headset. The ⏻ light flashes three times in red and you hear three beeps when the headset is being powered off.

Headset charging

After installing the headset charger, charge the headset as shown below. The headset is fully charged after three hours of continuous charging. If the ⏻ light does not turn on while charging, you need to charge the headset without interruption for at least 15 minutes to give the headset enough charge to use for a short time. For best performance, keep the headset in the headset charger when not in use.

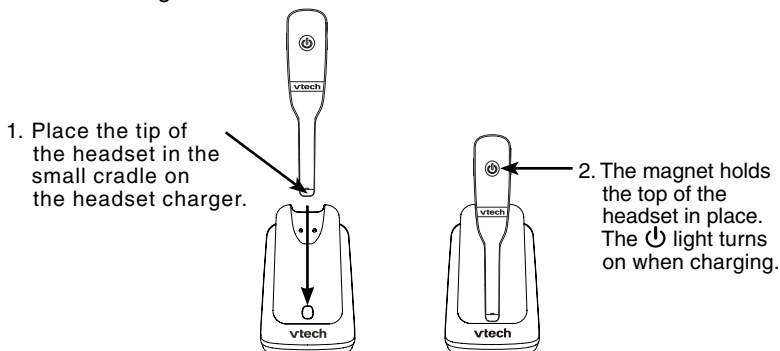

note

The headset battery is not replaceable.

Getting started

Headset battery



It takes up to three hours for the battery to be fully charged. When it is fully charged, you can expect the following performance:

Operation	Operating time
While in use (talking*)	Nine hours
While not in use (standby**)	Ninety hours



*Operating times vary depending on your actual use and the age of the battery.

**Headset is not charging or in use.

The battery needs charging when:

- The headset beeps twice every 20 seconds.
- The  light is off when in idle mode.
- The  light flashes every 10 seconds in red.

Conserve battery life:

- The headset battery is not replaceable.
- If the headset will not be used for a long period of time, press and hold  on the headset for two seconds to power off the headset and conserve the headset battery life. The  light flashes three times in red when the headset is being powered off.

CAUTION:

To prevent fire or shock hazard, do not expose this product to water or any type of moisture.

Getting started

Earbud installation

There are four earbuds provided and one of them has already been attached to the headset.

To remove the earbud from the headset earpiece:

Hold both sides of the earbud and then pull the earbud until it separates from the earpiece.

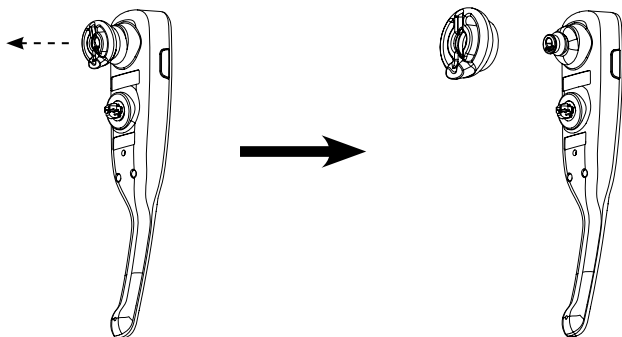

To attach the earbud to the headset earpiece:

1. Choose an appropriate earbud.
2. Press the earbud towards the earpiece until it clicks into place. Move the earbud around so that the protruding bump on the earbud is pointing towards your mouth when placed on your ear. The protruding bump on the earbud holds the headset securely in your ear.

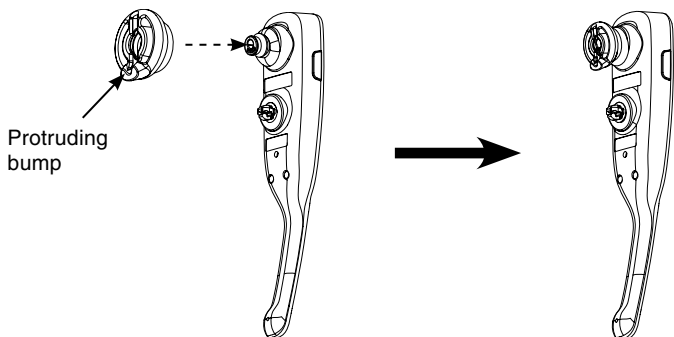

Getting started

Ear hook installation

There are three ear hooks provided. The smallest ear hook is a flexible ear hook. If you choose to use it, adjust to suit your ear comfortably before use.

To attach the ear hook to the headset:

1. Remove any headset attachment (earbud excluded) connected to the headset.
2. Choose an appropriate ear hook.
3. Insert the ear hook [A] into the rotating clip [B] on the headset until it clicks into place.

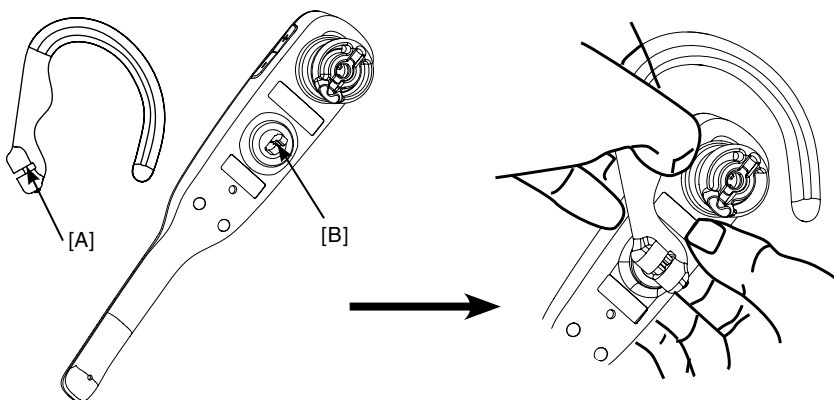

4. Hook the headset on your right ear. Adjust the angle of the headset until the microphone is pointing towards your mouth. Firmly grip the earpiece with one hand whenever adjusting the headset microphone up or down.

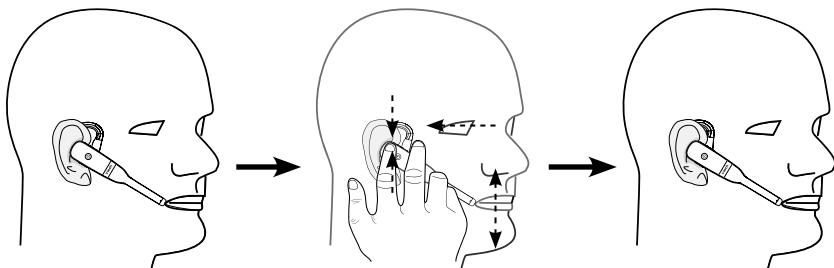

Getting started

Ear hook installation (continued)

To wear the headset on your left ear:

1. Hold the headset with one hand. Lift the ear hook upward.
2. Twist the ear hook 180 degrees clockwise.

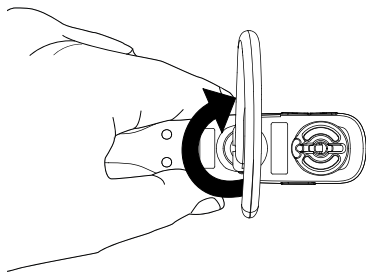
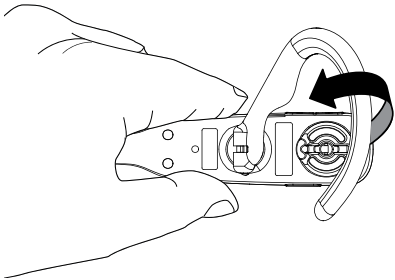

3. Push the ear hook downward.

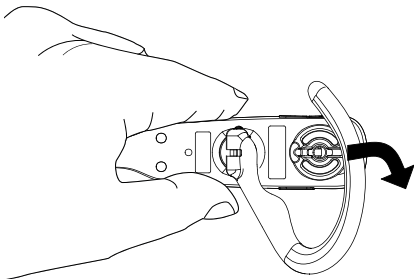

4. Hook the headset on your left ear. Adjust the angle of the headset until the microphone is pointing towards your mouth.

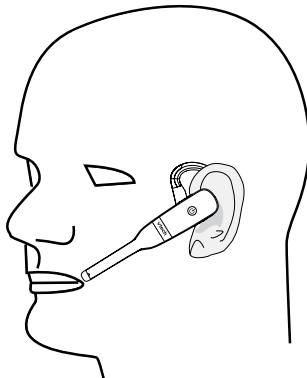

Getting started

Ear hook installation (continued)

To remove the ear hook from the headset:

1. Hold the headset with one hand and the ear hook with your other hand.
2. Pull the end of the ear hook up until it separates from the rotating clip on the headset.

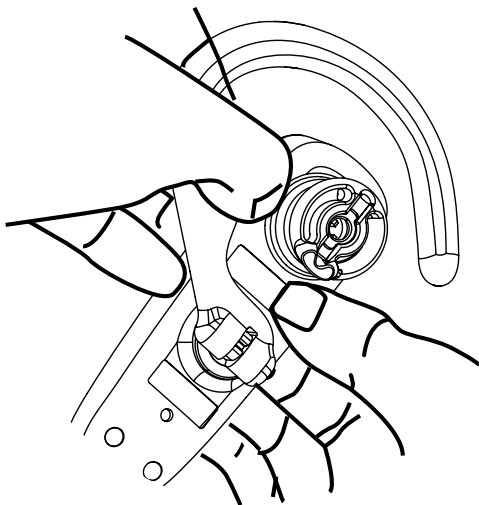

Getting started

Head band installation

To attach the head band to the headset:

1. Remove any headset attachment connected to the headset.
2. Attach the ear pad to the headset earpiece.

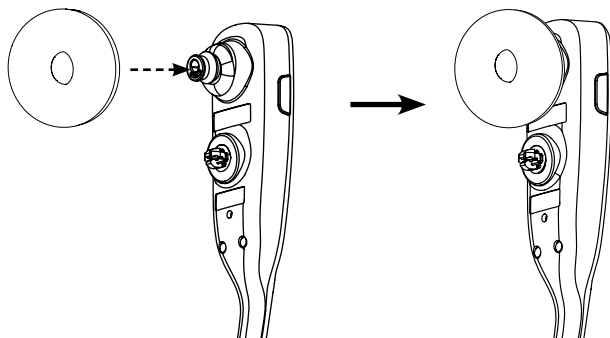

3. To wear the headset on your right ear, insert the end [A] of the head band into the rotating clip [B] on the headset until it clicks into place.

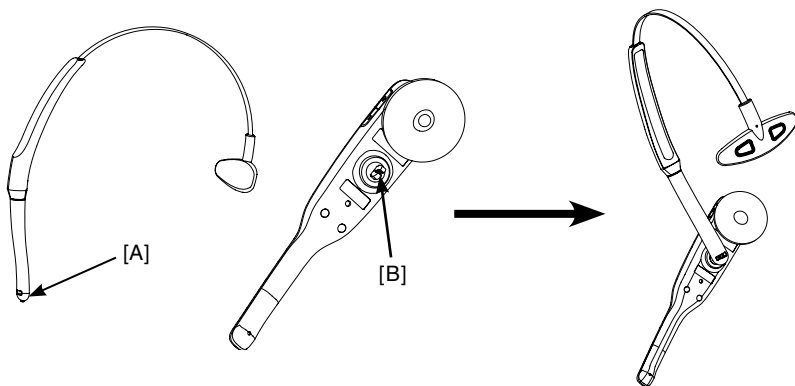

Getting started

Head band installation (continued)

4. Adjust the head band to fit your head. Adjust and rotate the angle of the headset until the microphone is pointing towards your mouth. Firmly grip the earpiece with one hand whenever adjusting the headset microphone up or down.

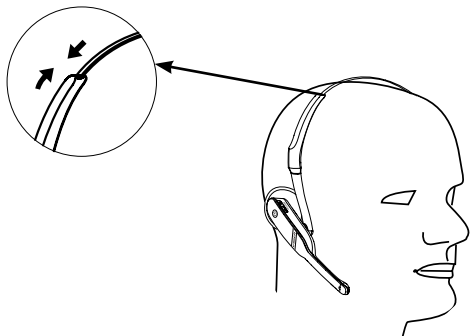

note To wear on your left ear, hold the headset on one hand and the head band with your other hand. Rotate the head band within the rotating clip on the headset.

To remove the head band from the headset:

1. Hold the headset with one hand and the head band with your other hand.
2. Pull the end of the head band until it separates from the rotating clip on the headset.

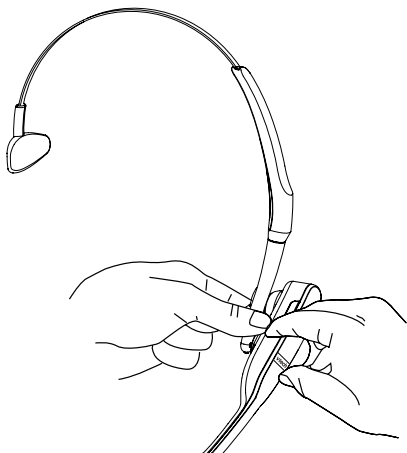

Getting started

Installation options

Your telephone base is ready for tabletop use. If you want to mount your telephone on a wall, use the provided wall mount bracket to connect with a standard dual-stud telephone wall mounting plate. If you do not have this mounting plate, you can purchase one from many hardware or consumer electronics retailers. You may need a professional to install the mounting plate.

Tabletop to wall mount installation

1. Plug one end of the telephone line cord into the **TEL LINE** jack on the bottom of the telephone base. Plug the small end of the telephone base power adapter into the **POWER** jack on the bottom of the telephone base.
2. Position the lower portion grooves on the telephone base to the lower portion tabs (marked **B**) on the wall mount bracket. Make sure the upper portion grooves of the telephone base are above the upper portion tabs (marked **A**) on the wall mount bracket. Push the telephone base down until it clicks securely in place.
3. Route the telephone line cord (or DSL filter) through the wall mount bracket hole and plug it into the telephone wall jack. Route the power cord out of the bottom of the telephone and plug it into an electrical outlet not controlled by a wall switch.
4. Align the holes on the bracket with the standard wall plate and slide the bracket down until it locks securely. Bundle the telephone line cord and power adapter cord neatly with twist ties.

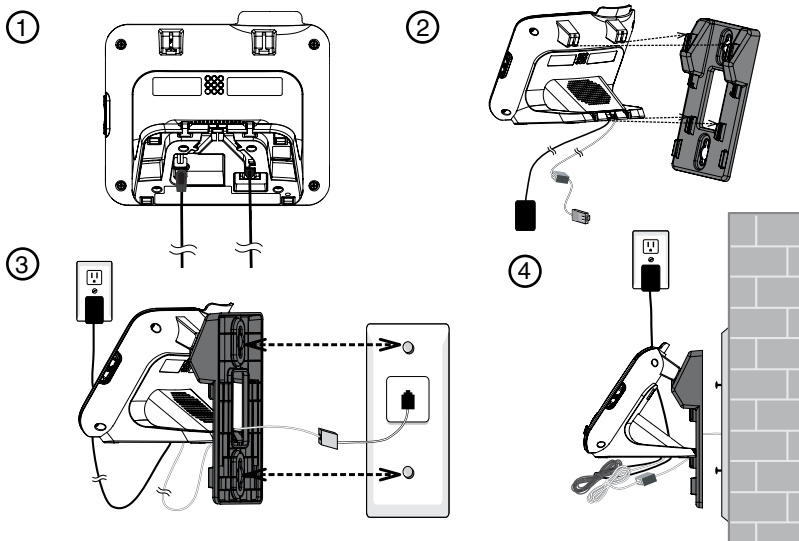

Getting started

Wall mount to tabletop installation

1. If the telephone line cord and power adapter cord are bundled, untie them first.
2. Slide the black wall mount bracket up and remove it from the wall plate. Unplug the telephone line cord (or DSL filter) from the wall. Unplug the power adapter from the power outlet.
3. Slide the telephone base up and remove it from the wall mount bracket.
4. See **Telephone base and charger installation** on page 3.

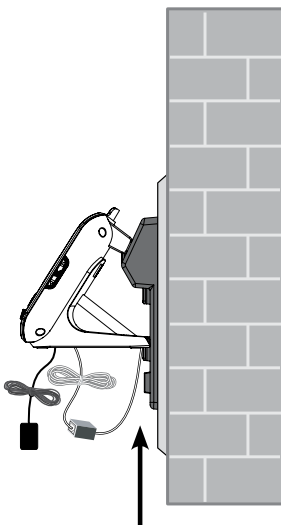

Getting started

Telephone base layout

REPEAT/◀

Press to repeat a message or press twice to play the previous message (page 90).

DELETE/X

Press to delete the message currently playing (page 90).
When the phone is not in use, press twice to delete all previously reviewed messages (page 92).

📶/FIND HANDSET

Press to page all system handsets and headset (page 55).

🔌/ANS ON/OFF

Press to turn the answering system on or off (page 81).

IN USE light

On when the handset or headset is in use.

Flashes when another telephone sharing the same line is in use or on hold.

Flashes quickly when there is an incoming home call.

Message window

Shows the number of messages and other answering system information (page 94).

▼/VOL/▲

Press to adjust the volume during message playback (page 91).
When the phone is not in use, press to adjust the telephone base ringer volume (page 49).

SKIP/▶

Press to skip to the next message (page 90).

PLAY/STOP/▶/■

Press to play messages (page 91).

Press to stop message playback (page 91).

D1/D2 lights

On when the telephone base is paired and connected with a Bluetooth device.

Flashes when there is an incoming cell call.

Alternate when the telephone base is in discoverable mode.

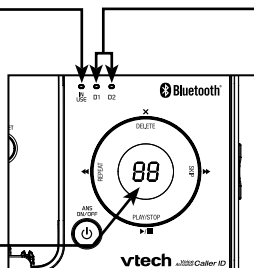
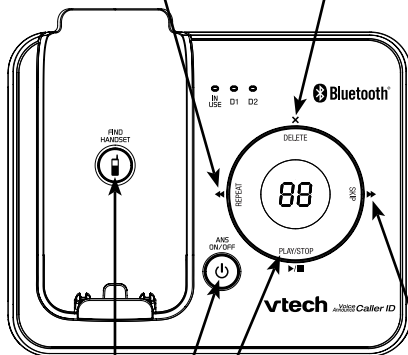

Getting started

Handset layout

CHARGE light

On when the handset is charging in the telephone base or charger.

Softkeys (2)

Press to select a menu item displayed above the key. While in a menu, press to select an item, or save an entry or setting.

📶/CELL

Press to make or answer a cell call (page 52). During a cell call, press to answer an incoming call when you hear a call waiting alert (page 52). Flashes quickly when there is an incoming cell call. Flashes slowly when a cell call is on hold.

🏠/HOME/FLASH

Press to make or answer a home call (page 50). During a home call, press to answer an incoming call when you hear a call waiting alert (page 51). Flashes quickly when there is an incoming home call. Flashes slowly when a home call is on hold.

1

While reviewing a caller ID log entry, press repeatedly to add or remove 1 in front of the telephone number before dialing or saving it in the directory (page 79).

*Tone

Press to switch to tone dialing temporarily during a call if you have pulse service (page 56). Press to toggle the name order when saving a caller ID entry into the directory (page 80).



Press to make or answer a home call using the handset speakerphone (page 50). During a call, message or announcement playback, press to switch between the speakerphone and the handset (page 55).

REDIAL/PAUSE

Press to review the redial list (page 59). While dialing or entering numbers into the directory, press and hold to insert a dialing pause (page 70).

↑↓EQ

During an outside call, intercom call, message or announcement playback, press to change the quality of the audio to best suit your hearing (page 57).

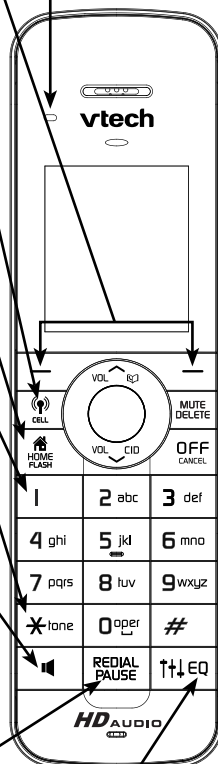

Getting started

Handset layout (continued)

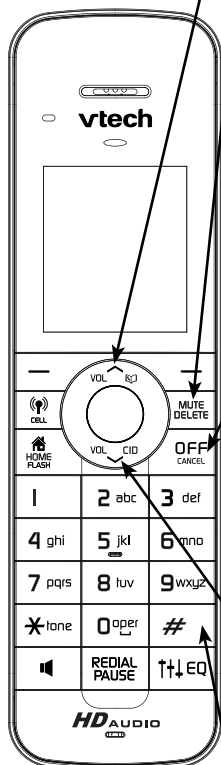

VOL/▲/□

While in a menu, press to scroll up.
During a call or message playback, press to increase the listening volume (page 55 or page 92).
When the handset is not in use, press to enter the directory (page 71).
When entering numbers and names in the directory, press to move the cursor to the left.

MUTE/DELETE

While on a call, press to mute the microphone (page 55).
While reviewing the caller ID log, directory or redial list, press to delete an individual entry (page 81, page 73 and page 60 respectively).
Press to delete digits when predialing (page 50).
While entering or editing a directory entry, press to erase a digit or character.
While the handset is ringing, press to silence the ringer temporarily.
During message or announcement playback, press to delete a message or announcement.

OFF/CANCEL

During a call, press to hang up (page 50 and page 52).
While the handset is ringing, press to silence the ringer temporarily (page 55).
Press and hold while the telephone is not in use to erase the displayed messages (**XX Missed calls** and **Download fail**).
While in a menu, press to exit without making changes or press and hold to return to idle mode.

VOL/▼/CID

While in a menu, press to scroll down.
During a call or message playback, press to decrease the listening volume (page 55 or page 92).
When the handset is not in use, press to review the caller ID log (page 78).
When entering numbers and names in the directory, press to move the cursor to the right.

(pound key)

While reviewing a caller ID log entry or a directory entry, press repeatedly to show other dialing options (page 79 and page 72 respectively).

Getting started

Handset layout (continued)

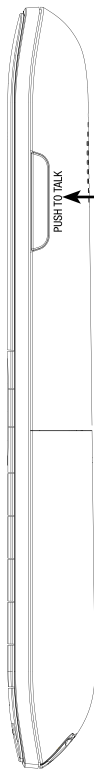

PUSH TO TALK (PTT)

Press to begin a one-to-one or one-to-group broadcast (page 65 and page 66).

Press and hold to begin a broadcast to a group of handsets when the handset is not in use (page 66).

Getting started

Headset layout



 (on/off)

- Press and hold two seconds to power on or off.
- Press to answer, end or join a call (pages 50, 52 and 61).
- On in red when charging in the headset charger.
- On in blue when fully charged in the headset charger.
- Flashes once every 10 seconds in blue when in idle mode.
- Flashes once every 10 seconds in red when in low battery mode.
- Flashes twice every three seconds in blue while on a call.
- Flashes quickly in blue while being paged.
- Flashes quickly and alternately in red and blue while being registered.
- Flashes four times every four seconds in blue when there is an incoming call.

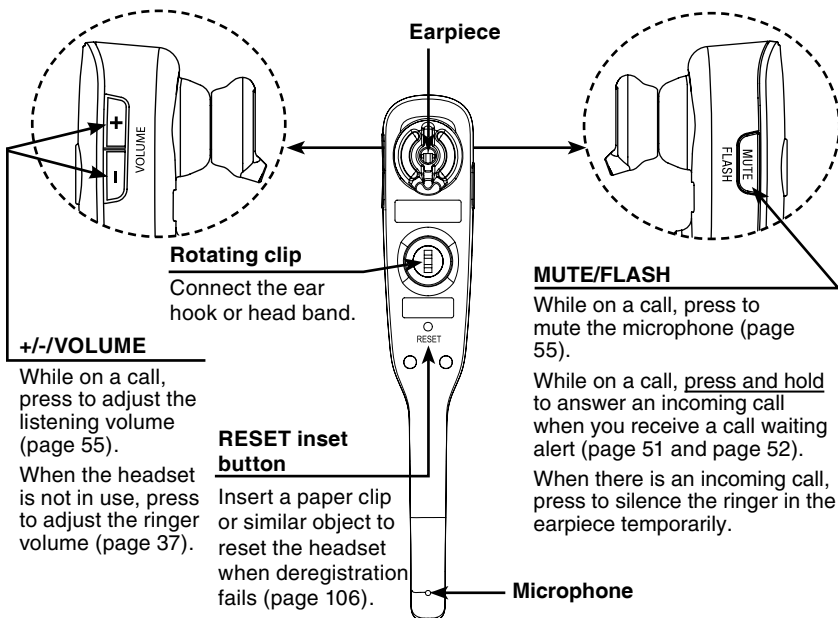

Earpiece

Rotating clip

Connect the ear hook or head band.

MUTE/FLASH

While on a call, press to mute the microphone (page 55).

While on a call, press and hold to answer an incoming call when you receive a call waiting alert (page 51 and page 52).

When there is an incoming call, press to silence the ringer in the earpiece temporarily.

+/-/VOLUME

While on a call, press to adjust the listening volume (page 55).

When the headset is not in use, press to adjust the ringer volume (page 37).

RESET inset button

Insert a paper clip or similar object to reset the headset when deregistration fails (page 106).

Microphone

Getting started

Handset main menu

To enter the main menu:

1. Press **MENU** when the handset is not in use.
2. Press ∇ or \blacktriangle to highlight a handset feature menu, then press **SELECT** to enter that menu.

To return to the previous menu, press **OFF/CANCEL**.

To return to idle mode, press and hold **OFF/CANCEL**.

Play messages - play messages from the answering system.



Answering sys - record memos and change your answering system settings.



Directory - store and search for names and numbers.



Caller ID log - review the caller ID history or delete all caller ID log entries.



Intercom - make intercom calls to a system handset.



Bluetooth - set up and manage your Bluetooth enabled devices.



Getting started

Handset main menu (continued)

Ringers - set up ringers for the home and cell lines.



Set date/time - set up the date and time of your telephone.



Settings - change your telephone settings.



Website - displays the VTech website address.



Bluetooth

Introducing Bluetooth

Your new **DS6472** telephone system with Bluetooth wireless technology has the following features:

- Pair up to four Bluetooth enabled devices (cell phones or headsets) with the telephone base.
- Connect a maximum of two cell phones to make and receive cell calls. Only one cell phone can be active on a call at a time.
- Connect one Bluetooth enabled headset for making and receiving home calls.
- Conference cell and home calls.
- Make and receive calls using your cell phone plan while utilizing the ease and comfort of your home telephone system.

IMPORTANT INFORMATION

- After plugging in the telephone base, wait at least 20 seconds before connecting a Bluetooth device. The screen shows **Bluetooth system busy** if you try to connect too soon.
- Refer to the user's manual of your Bluetooth enabled cell phone or headset for more information about how that device uses Bluetooth connectivity.
- Bluetooth wireless technology operates within a short range (a maximum of approximately 30 feet) from the telephone base. Keep connected cell phones and headset within this range.
- If your cell phone has poor reception in your home, the **DS6472** cannot improve the reception. However, if there is a location in your house with better reception, you can leave your cell phone at that location while you use the **DS6472** cell line. In order for this to work, the telephone base must be within 30 feet of the cell phone.
- Charge your cell phone while it is connected to the telephone base. Your cell phone's battery will discharge faster while it is connected to the telephone base via Bluetooth wireless technology.
- Monitor your cell phone's usage because minutes are deducted from your cellular plan for the duration of all cell calls.

Refer to **Bluetooth setup** (page 25) to learn how to set up and manage your Bluetooth enabled devices. Refer to **Telephone operation** (page 50) on how to operate your Bluetooth devices with your new **DS6472** telephone system with Bluetooth wireless technology. Refer to **Troubleshooting** (page 107) if you experience difficulty using the telephone system.

The *Bluetooth*[®] word mark and logos are owned by Bluetooth SIG, Inc. and any use of such marks by VTech Holdings Limited is under license. VTech Holdings Limited is a member of Bluetooth SIG, Inc. Other trademarks and trade names are those of their respective owners.

Bluetooth

Glossary of terms

Below are some terms used in this user's manual to help you become familiar with using your Bluetooth enabled devices and your new **DS6472** telephone system.

Active device slots - the **Device list** has two active slots for two cell phones, or one cell phone and one headset. When a device on the list is active, **D1** or **D2** displays in front of the device name. In order to use a Bluetooth device on a call, it must be in an active slot and be connected.

Bluetooth cell phone - refers to a Bluetooth enabled cellular telephone.

Cell line - the telephone line associated with your cell phone service. On your **DS6472** handset, press /CELL to use the cell line.

Connected - when you pair a Bluetooth device to the **DS6472**, it is placed in an active slot and automatically connected. When a device is connected, **1** and/or **2** displays after  on the handset and the **D1** and/or **D2** light on the telephone base is on. If a device loses its connection to the telephone base, it must be reconnected before you can use the device with the **DS6472**.

Disconnected - when a device is disconnected, **1** and/or **2** displays after  on the handset and the **D1** and/or **D2** light on the telephone base is off.

Discoverable mode - before a Bluetooth enabled device can be paired, it must be set to this mode. When pairing your cell phone, the telephone base will be set to this mode. When pairing a headset, the headset must be set to this mode. Depending on the manufacturer, this mode is sometimes referred to as **Find Me** or **Visibility**.

Home line - your conventional telephone land line. On your **DS6472** handset, press /HOME/FLASH to use the home line.

Paired devices - once Bluetooth enabled devices have been paired with the telephone base, they appear on the device list. A maximum of four devices can be paired with the telephone base.

Pairing - this refers to the process of Bluetooth enabled devices registering device information with each other. The telephone base must be paired with a Bluetooth enabled cell phone or headset before the Bluetooth device can be used. Depending on the manufacturer, this is also referred to as **Bonding**.

PIN - by default, the PIN is **0000** for the telephone base and for most Bluetooth devices. PIN information must be exchanged between Bluetooth devices before they can be used. This is also known as a **Passkey** or **Passcode**.

Bluetooth

Bluetooth setup

To use a Bluetooth enabled cell phone or headset with your **DS6472**, you must first pair and connect your Bluetooth device(s) with the telephone base. All **DS6472** handsets can be used to make or answer on the cell phone line.

Bluetooth wireless technology operates within a short range (30 feet). When you pair a Bluetooth cell phone or Bluetooth headset to the telephone base, move closer to the telephone base to maintain sufficient signal strength.

Add a cell phone

Before you begin, make sure that you have cellular coverage and your Bluetooth enabled cell phone is not connected to any other Bluetooth devices. Refer to your cell phone user's manual to learn how to search for or add new Bluetooth devices.

To pair and connect a cell phone:

1. Press **MENU** on the handset when it is not in use.
2. Press **∨** or **∧** to highlight **Bluetooth**, then press **SELECT**.
3. Press **SELECT** to choose **Add device**, then press **SELECT** to choose **Add cellular**. The handset displays **Please wait...** followed by **1. If cell is connected to BT device, please disconnect it.**
 - If there are already four paired devices on the device list, the 4th device on the device list will be automatically removed, regardless of whether the new device pairing is successful or not (page 32).
 - If there are already two active devices on the device list with prefix **D1:** or **D2:**, the handset shows **Only 2 devices can be ready for connection**. You are prompted to deactivate an active device.
4. Press **NEXT**. The handset displays **2. Place cell phone next to base.**
 - All devices that are connected to the telephone base are disconnected until the pairing process is completed.

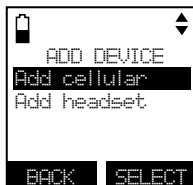

Bluetooth

Add a cell phone (continued)

5. Press **NEXT** to turn on the telephone base discoverable mode. The handset displays **Set cell to search base: VTech DS6472 discoverable PIN: 0000**. Promptly turn on the Bluetooth feature of your cell phone and search for or add new devices.
 - Your cell phone may require a passcode. In this case, the handset displays **Check cellular. ENTER PASS CODE**. Enter the cell phone passcode into the handset and press **SET** to save.
6. Enter the PIN of the telephone base (the default PIN is **0000**) into your cell phone to continue the pairing process. The handset displays **Adding Cell Phone A to device list...**
7. When a device is successfully connected, the handset displays **Cell Phone A is added and connected to base**. You hear a confirmation tone. The corresponding status icon (📶 1 or 📶 2) displays. The corresponding device light on the telephone base (**D1** or **D2**) turns on.

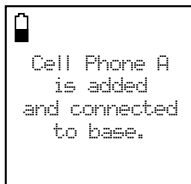
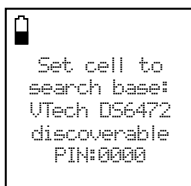

If you have trouble pairing your cell phone, it may not be compatible with your DS6472. Check the Bluetooth compatibility list at www.vtechphones.com.

note

- The pairing process may take up to one minute. If the pairing process fails, try again.
- The steps for the pairing process may vary for different cell phones. If this happens, follow the prompts on your cell phone and your **DS6472** to complete the pairing process.
- If you put the handset back in the telephone base or charger while pairing, the pairing is canceled and the handset returns to idle mode.

Bluetooth

Add a headset

Before you begin, make sure that your Bluetooth enabled headset is not connected to any other Bluetooth device. Refer to your headset user's manual to learn how to search for or add new Bluetooth devices.

To pair and connect a headset:

1. Press **MENU** on the handset when it is not in use.
2. Press **∨** or **∧** to highlight **Bluetooth**, then press **SELECT**.
3. Press **SELECT** to choose **Add device**.
4. Press **∨** or **∧** to highlight **Add headset**, then press **SELECT**. The handset displays **If headset is connected to cell, please disconnect it**. Press **NEXT**.
 - When there is already an active headset, the handset shows **Only 1 headset in device list can be ready for connection** and then prompt you to replace an existing paired device (page 32).
 - When there are already two active devices, the handset shows **Only 2 devices can be ready for connection**. The telephone base will deactivate another headset from an active slot automatically.
5. The handset displays **Pls set headset to discoverable mode**, then press **NEXT**.
 - All devices that are connected to the telephone base are temporarily disconnected.
6. The handset displays **Searching for Bluetooth headsets...** Set your headset to discoverable mode (refer to the user's manual of your headset).
7. When the handset displays the found devices, press **∨** or **∧** to highlight a desired headset and then press **SELECT**.
8. Enter the PIN of your headset. The PIN for most Bluetooth devices is **0000** (refer to the user's manual of your headset). Then press **NEXT**. The handset displays **Adding Headset A to device list...** when the base is connecting to your headset.

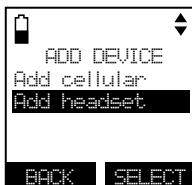

Bluetooth

Add a headset (continued)

9. When a device is successfully connected, the handset displays **Headset A is added and connected to base** and the corresponding status icon (📶 1 or 📶 2). You hear a confirmation tone. The corresponding light on the telephone base (**D1** or **D2**) turns on.



If you have trouble pairing your headset, it may be not compatible with your DS6472. Check the Bluetooth compatibility list at www.vtechphones.com.

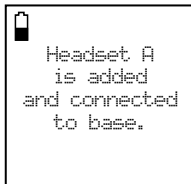

note

- The pairing process may take up to one minute. If the pairing process fails, try again.
- If you put the handset back in the telephone base or charger while pairing, the process discontinues and the handset returns to idle mode.

Auto connection

An active device may be disconnected from the telephone base when:

- The Bluetooth feature of your connected cell phone is turned off.
- The power of your device is turned off.
- Your Bluetooth device is not within range of the telephone base.

When the Bluetooth feature or power on the device is turned on, or it moves within range of the base, the base will try to reconnect to the Bluetooth device. If you disconnect the device through the device list, the base will not attempt to reconnect unless your device is moved out of range and back in range again.

Bluetooth

Connecting devices

Up to four devices can be paired to the telephone base. All paired devices are shown on the device list. To use a paired device, it must be in an active slot (**D1** or **D2**) on the device list and connected. Only one Bluetooth cell phone or a headset can be on a call at a time.

Once you have paired a device with the telephone base, you do not need to repeat the pairing procedure again unless you delete the device from the device list.

note

When connecting a Bluetooth device to the device list, all connected devices will be temporarily disconnected until the procedure is complete. It may take up to two minutes to reconnect.

Review the device list

1. Press **MENU** on the handset when it is not in use.
2. Press \downarrow or \uparrow to highlight **Bluetooth**, then press **SELECT**.
3. Press \downarrow or \uparrow to highlight **Device list**, then press **SELECT**.



Connect/Disconnect an active device

While in the device list menu, you may connect or disconnect your devices.

1. Press **MENU** on the handset when it is not in use.
2. Press \downarrow or \uparrow to highlight **Bluetooth**, then press **SELECT**.
3. Press \downarrow or \uparrow to highlight **Device list**, then press **SELECT**.
4. Press \downarrow or \uparrow to highlight a device when necessary, then press **OPTION**.
5. Press \downarrow or \uparrow to highlight **Connect/Disconnect** (whichever is applicable), then press **SELECT** to confirm. The handset displays **Device connected/Device disconnected**. You hear a confirmation tone.

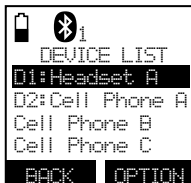

note

When your device is connected, you will be prompted to select **Disconnect**. When your device is disconnected, you will be prompted to select **Connect**.

Bluetooth

Remove a device

When you already have the maximum of four paired devices on the device list and you want to add another device, you must first delete a device from the device list.

1. Press **MENU** on the handset when it is not in use.
2. Press \downarrow or \uparrow to highlight **Bluetooth**, then press **SELECT**.
3. Press \downarrow or \uparrow to highlight **Device list**, then press **SELECT**.
4. Press \downarrow or \uparrow to highlight a desired device when necessary, then press **MUTE/DELETE**.
- OR -
 - Press \downarrow or \uparrow to highlight a desired device when necessary, then press **OPTION**.
 - Press \downarrow or \uparrow to highlight **Remove**, then press **SELECT**.
5. The handset displays **Remove Headset A?** Press **YES** to confirm. The handset displays **Device removed from device list**. You hear a confirmation tone.



Bluetooth

Rename a device

You can change the name of a device on the device list.

1. Press **MENU** on the handset when it is not in use.
2. Press \vee or \wedge to highlight **Bluetooth**, then press **SELECT**.
3. Press \vee or \wedge to highlight **Device list**, then press **SELECT**.
4. Press \vee or \wedge to choose a desired device when necessary, then press **OPTION**.
5. Press \vee or \wedge to highlight **Rename**, then press **SELECT**. The handset displays **ENTER NEW NAME**.
6. Use the dialing keys to edit the name (up to 15 characters).
 - Press **MUTE/DELETE** to erase a character.
 - Press and hold **MUTE/DELETE** to erase all characters.
 - Press \vee to move the cursor to the right or \wedge to the left.
7. Press **SAVE**. The handset displays **Device renamed**. You hear a confirmation tone.



Bluetooth

Replace an active device

If you already have two active devices on the device list and you want to activate a different device, you must deactivate one of the two active devices.

To replace an active device:

1. Press **MENU** on the handset when it is not in use.
2. Press **∨** or **∧** to highlight **Bluetooth**, then press **SELECT**.
3. Press **∨** or **∧** to highlight **Device list**, then press **SELECT**.
4. Press **∨** or **∧** to highlight the device you want to activate, without a prefix **D1:** or **D2:**, then press **OPTION**.
5. Press **∨** or **∧** to highlight **Connect**, then press **SELECT**. The handset displays **Only 2 devices can be ready for connection** and then a list of devices for deactivation.
6. Press **∨** or **∧** to highlight the device to be deactivated, then press **NEXT**. The handset displays **Cell Phone/Headset A is deactivated** and you hear a confirmation tone. The handset displays **Connecting Cell Phone/Headset B to the base...**
7. Depending on your cell phone settings, you may need to press a key on your cell phone to confirm the connection. When the new device is successfully activated and connected, the handset displays **Device connected**. You hear a confirmation tone.

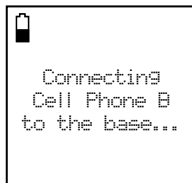
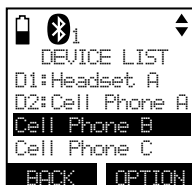

Bluetooth connection from idle mode

When you have active devices that are not connected, **CONNECT** appears on the idle handset. Press **CONNECT** to start connecting an active device. When there are two active devices, the handset will prompt you to choose one before connection.



Bluetooth

Download directory

You can download up to four cell phone directories (phonebooks) to your **DS6472** telephone system via Bluetooth wireless technology. Each downloaded directory can store up to 1,500 entries with up to 30 digits for each phone number and 15 characters for each name.

Before downloading the directory, make sure the cell phone is paired, active and connected to the **DS6472**. Make sure the handset battery is charged for at least 10 minutes.

Place your cell phone next to the telephone base when you download a cell phone directory to your DS6472.

To download a cell phone directory:

1. Press **MENU** on the handset when it is not in use.
2. Press **▼** or **▲** to highlight **Bluetooth**, then press **SELECT**.
3. Press **▼** or **▲** to highlight **Download dir**, then press **SELECT**.
 - If there is no cell phone paired to the system, the handset displays **Device list is empty**. Press **OK** to return to the **Bluetooth** menu.
4. Press **▼** or **▲** to highlight a desired device, then press **SELECT**.
 - If the selected device is active but disconnected, the handset displays **Cellular phone not connected**. Press **CONNECT**.
5. Press **▼** or **▲** to highlight one of the following options:
 - **Phone memory** - download all contacts stored in your phone memory.
 - **SIM card only** - download all contacts stored in your SIM card.
 - **Phone and SIM** - download all contacts stored in both your phone memory and SIM card.

Press **SELECT**. During the download, the handset displays the progress. All other idle system handsets display **Downloading dir**.

- Your cell phone may require a passcode. In this case, the handset displays **Check cellular**. **ENTER PASS CODE**. Enter the cell phone passcode into the handset and press **SET** to save.

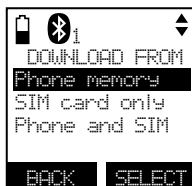

Bluetooth

Download directory (continued)

- If the selected device's directory has already been downloaded to the **DS6472** before, the handset displays the last update date of your cell phone. The directory stored on the **DS6472** for that cell phone will be erased and replaced with the current cell phone directory. If you have edited the downloaded entries (page 72), those changes will be lost. Press **NEXT** to start the download, the handset displays **Erasing directory...**
 - If you already have four downloaded directories, the handset displays **Memory is full. Replace existing directory?** Press **YES**. Highlight the cell phone directory to be replaced and then press **SELECT**. The handset displays **Replace Cell Phone A directory?** Press **YES** to confirm.
6. When the downloading process is complete, the handset displays **Download ended XXXX entries saved**. You hear a confirmation tone. Press **OK** to return to the download directory menu.

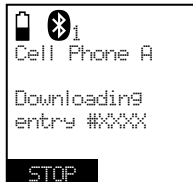

note

- Certain cell phones do not support SIM card download. If this is the case, try transferring the contacts from your SIM card to your cell phone memory first, then download from your cell phone memory. For more information on how to transfer contacts from your SIM card to your cell phone memory, see the user's manual of your cell phone.
- When downloading the directory from your Bluetooth enabled cell phone, some data may not transfer. For example, if you have home, mobile and work numbers for a particular contact, the three categories may not transfer to your **DS6472**.
- For certain cell phones, you may need to press a key on your cell phone to confirm the directory download.

Bluetooth

Interruption to directory download

When you are downloading a directory from a cell phone and the phone receives a call, the download process stops and all handsets display **Download fail** after the call ends. When you try to view the downloaded directory, the handset displays **Last download failed: MM/DD/YY**. You need to download the directory again (see page 33).

When you are downloading a directory from a cell phone and the telephone base loses power, the download process stops. When the telephone base regains power, the handset only displays the **Home** directory. You need to download the directory again (see page 33).

The download progress screen may be replaced with **Cell line in use**. To go back to the downloading progress screen, do steps one through four on page 33. The download process continues even if any of the following occurs:

- You place the handset in the telephone base or charger.
- You access your cell phone menu features.
- The handset battery becomes depleted or the handset loses connection with the telephone base.



note During the download process, do not attempt to make changes to your cell phone directory.

View the directory download information

1. Press **MENU** on the handset when it is not in use.
2. Press \downarrow or \uparrow to highlight **Directory**, then press **SELECT**.
3. Press \downarrow or \uparrow to choose the desired downloaded directory, then press **OPTION**.
4. Press \downarrow or \uparrow to highlight **Last update**, then press **SELECT**. Press **OK** to exit.

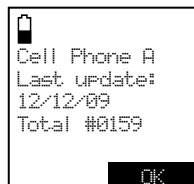

Bluetooth

Change PIN

You are required to enter a PIN when establishing a Bluetooth connection. The default PIN of your telephone base is **0000**.

To change the PIN:

1. Press **MENU** on the handset when it is not in use.
2. Press **∨** or **∧** to highlight **Bluetooth**, then press **SELECT**.
3. Press **∨** or **∧** to highlight **Change PIN**, then press **SELECT**. The handset displays **ENTER NEW PIN** and the existing PIN.
4. Use the dialing keys to enter a new four-digit code.
 - Press **MUTE/DELETE** to erase a digit.
 - Press and hold **MUTE/DELETE** to erase all digits.
 - Press **∨** to move the cursor to the right or **∧** to the left.
5. Press **SET** to save. You hear a confirmation tone.



Telephone settings

Handset settings

Ringers

In the ringers menu, you can select the ringer tones and adjust the ringer volume for incoming calls to the home and cell lines.

Ringer volume (handset)

You can adjust the ringer volume for the incoming home and cell calls.



To adjust the handset ringer volume:

1. Press **MENU** on the handset when it is not in use.
2. Press \vee or \wedge to highlight **Ringers**, then press **SELECT**.
3. Press **SELECT** to choose **Ringer volume**.
4. Press \vee or \wedge to highlight **All lines**, **Home**, **Cell-D1**, or **Cell-D2** then press **SELECT**.
5. Press \vee or \wedge to sample each volume level.
6. Press **SET** to save. You hear a confirmation tone.
- OR -

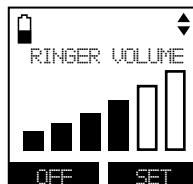
Press **OFF** to turn off the ringer, then press **SET** to save. You hear a confirmation tone.



note

- When the ringer volume for all are set to off, a ringer off icon  appears steady. When only one or two of the ringer volume is set to off, a ringer off icon  flashes.
- When the ringer volume is set to off, the handset displays briefly **Caller ID won't be announced** if the caller ID announce feature is turned on (page 46).
- See page 49 to set the telephone base ringer volume.

Ringer volume (headset)

The headset does not have an external ringer. When there is an incoming call, the headset earpiece rings.

To adjust the ringer volume:

Press **+/-VOLUME** on the side of the headset when it is not in use.

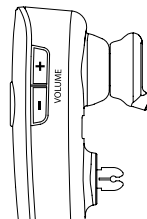

Telephone settings

Ringer tone

You can select the ringer tones for the incoming home and cell calls.

To select a ringer tone:

1. Press **MENU** on the handset when it is not in use.
2. Press **▼** or **▲** to highlight **Ringers**, then press **SELECT**.
3. Press **▼** or **▲** to highlight **Ringer tone**, then press **SELECT**.
4. Press **▼** or **▲** to highlight **All lines**, **Home**, **Cell-D1** or **Cell-D2**, then press **SELECT**.
5. Press **▼** or **▲** to sample each ringer tone.
6. Press **SET** to save. You hear a confirmation tone.



note

When you turn off the ringer volume, you will not hear ringer tone samples.

Telephone settings

Set date and time

The answering system announces the day and time of each message prior to playing it. If you subscribe to caller ID service, the day, month and time are set automatically with each incoming call. If you do not want to set the date and time automatically with caller ID information, turn this feature off (see **CID time synchronization** on page 44). However, the year must be correct so that the day of the week can be calculated from the caller ID information. Before using the answering system, set the date and time as follows.

To set the date and time manually:

1. Press **MENU** on the handset when it is not in use.
2. Press **∨** or **∧** to highlight **Set date/time**, then press **SELECT**.
3. Use the dialing keys (**0-9**) to enter the month. For example, enter **02** for February.
- OR -
Press **∨** or **∧** to choose the month and then press **SET**.
4. Repeat Step 3 to set the date and year, and then press **SET**.
5. Repeat Step 3 to set the hour and minute, and then press **SET**.
6. Press **∨** or **∧** to choose **AM** or **PM**, or press **2** for **AM** or **7** for **PM**. Then press **SET** to save. You hear a confirmation tone.

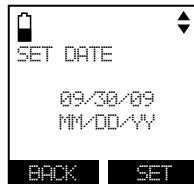

note

If the date and time are not set, the system announces, "Time and day not set," before each message plays.

Telephone settings

Settings

In the settings menu, you can modify the settings for LCD language, voice language, display alerts, CID time synchronization, handset name, key tone, dial mode and caller ID announce.

LCD language

You can select a language (English, French or Spanish) to be used in all screen displays.

To select a language:

1. Press **MENU** on the handset when it is not in use.
2. Press **^** or **v** to highlight **Settings**, then press **SELECT**.
3. Press **SELECT** to choose **LCD language**.
4. Press **^** or **v** to choose from **English**, **Français** or **Español**, then press **SET** to save. You hear a confirmation tone.



Voice language

You can select a language (English or French) to be used for the answering system's voice prompts and caller ID announce feature.

1. Press **MENU** on the handset when it is not in use.
2. Press **^** or **v** to highlight **Settings**, then press **SELECT**.
3. Press **^** or **v** to highlight **Voice language**, then press **SELECT**.
4. Press **^** or **v** to highlight **Answering sys** or **AnnC Caller ID**, then press **SELECT**.
5. Press **^** or **v** to choose from **English** or **Français**, then press **SET** to save. You hear a confirmation tone.



Telephone settings

Display alerts

In the display alerts menu, you can change and edit the settings for display alerts on the idle screen.

Missed call indicator

When there are missed calls that have not been reviewed in the caller ID log, the handsets show **XX Missed calls**.

Each time you review a caller ID log entry marked **NEW**, the number of missed calls decreases by one.

When you have reviewed all the missed calls, the missed calls indicator disappears.

If you do not want to review the missed calls one by one, you can reset the missed call indicator. All the entries are then considered old and kept in the caller ID log.

To reset the missed call indicator:

1. Press **MENU** on the handset when it is not in use.
2. Press \downarrow or \uparrow to highlight **Settings**, then press **SELECT**.
3. Press \downarrow or \uparrow to highlight **Display alerts**, then press **SELECT**.
4. Press \downarrow or \uparrow to highlight **Home line** or **Cell line**, then press **SELECT**.
5. Press **SELECT** to choose **Missed calls**. The handset displays **Reset missed call indication?** Press **YES** to confirm. You hear a confirmation tone.

You can also press and hold **OFF/CANCEL** to erase the missed call indicator when the telephone is not in use.



Telephone settings

Display alerts (continued)

Voicemail indicators

If you subscribe to voicemail service offered by your telephone service provider, **New voicemail** and  appear on the handsets when you have new voicemail messages. Contact your telephone service provider for more information and assistance about using your voicemail service.

After you have listened to all new voicemail messages, the indicators on the handsets turn off automatically.

Reset the voicemail indicators when the telephone indicates that there is new voicemail but there is none (for example, when you have accessed your voicemail while away from home). Clearing the voicemail waiting indicators only turns off the indicators; it does not delete your voicemail messages. As long as you have new voicemail messages, your telephone service provider continues to send the signal to turn on the indicators.

To reset the voicemail indicators:

1. Press **MENU** on the handset when it is not in use.
2. Press **▼** or **▲** to highlight **Settings**, then press **SELECT**.
3. Press **▼** or **▲** to highlight **Display alerts**, then press **SELECT**.
4. Press **▼** or **▲** to highlight **Home line**, then press **SELECT**.
5. Press **▼** or **▲** to highlight **Voicemail**, press **SELECT**.
6. The handset displays **Reset voicemail indication?** Press **YES** to confirm. You hear a confirmation tone.

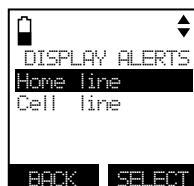

Telephone settings

Display alerts (continued)

No line

If there is no telephone line connected to the telephone base, the handsets show **No home line**. If you do not want to display the message on the handsets (for example, if you use the cell line only), you can turn off the no line alert.

To turn the no line alert on or off:

1. Press **MENU** on the handset when it is not in use.
2. Press **▼** or **▲** to highlight **Settings**, then press **SELECT**.
3. Press **▼** or **▲** to highlight **Display alerts**, then press **SELECT**.
4. Press **▼** or **▲** to highlight **Home line**, then press **SELECT**.
5. Press **▼** or **▲** to highlight **No line**, then press **SELECT**.
6. Press **▼** or **▲** to choose **On** or **Off**, then press **SET** to save. When you choose **Off**, the handset displays **If the line is not connected, an alert will not appear**. You hear a confirmation tone.



Download fail

If the directory download process is interrupted, the handsets display **Download fail**. You can reset the download fail indication on the handset.

To reset the download fail indication:

1. Press **MENU** on the handset when it is not in use.
2. Press **▼** or **▲** to highlight **Settings**, then press **SELECT**.
3. Press **▼** or **▲** to highlight **Display alerts**, then press **SELECT**.
4. Press **▼** or **▲** to highlight **Cell line**, then press **SELECT**.
5. Press **▼** or **▲** to highlight **Download fail**, then press **SELECT**.
6. The handset displays **Reset download failure indication?** Press **YES** to confirm. You hear a confirmation tone.

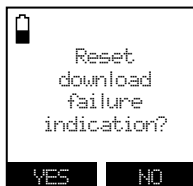
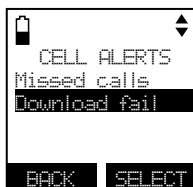

You can also press and hold **OFF/CANCEL** to erase this indication when the telephone is not in use.

Telephone settings

CID time synchronization

If you subscribe to caller ID service, the date and time will be set automatically by the caller ID information. You can turn off this feature if you want to set the date and time manually.

To change the setting:

1. Press **MENU** on the handset when it is not in use.
2. Press **▼** or **▲** to highlight **Settings**, then press **SELECT**.
3. Press **▼** or **▲** to highlight **CID time sync**, then press **SELECT**.
4. Press **▼** or **▲** to choose **On** or **Off**, then press **SET** to save. You hear a confirmation tone.



Rename handsets

You can create a name for each handset. The new name can be up to 11 characters.

To rename a handset:

1. Press **MENU** on the handset when it is not in use.
2. Press **▲** or **▼** to highlight **Settings**, then press **SELECT**.
3. Press **▲** or **▼** to highlight **Rename handset**, then press **SELECT**. The handset displays **RENAME HANDSET**.
4. Use the dialing keys to edit the name.
 - Press **MUTE/DELETE** to erase a character.
 - Press and hold **MUTE/DELETE** to erase all characters.
 - Press **▼** to move the cursor to the right or **▲** to the left.
5. Press **SAVE**. You hear a confirmation tone.



Telephone settings

Key tone

You can change the volume of the key tone or turn it off.

To change the setting:

1. Press **MENU** on the handset when it is not in use.
2. Press \downarrow or \uparrow to highlight **Settings**, then press **SELECT**.
3. Press \downarrow or \uparrow to highlight **Key tone**, then press **SELECT**.
4. Press \downarrow or \uparrow to sample each volume level. Press **SET** to save.
- OR -
Press **OFF** to turn off the key tone, then press **SET** to save. You hear a confirmation tone.

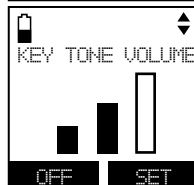

Dial mode

The dial mode is preset to tone dialing. If you have pulse (rotary) service, you must change the dial mode to pulse dialing before using the telephone.

To change the setting:

1. Press **MENU** on the handset when it is not in use.
2. Press \downarrow or \uparrow to highlight **Settings**, then press **SELECT**.
3. Press \downarrow or \uparrow to highlight **Dial mode**, then press **SELECT**.
4. Press \downarrow or \uparrow to choose **Tone** or **Pulse**, then press **SET** to save. You hear a confirmation tone.



Telephone settings

Caller ID announce

You can set your handset and/or telephone base to announce the caller ID information for incoming calls. The caller ID announce setting is independent for each handset and the telephone base.

To change the setting:

1. Press **MENU** on the handset when it is not in use.
2. Press \downarrow or \uparrow to highlight **Settings**, then press **SELECT**.
3. Press \downarrow or \uparrow to highlight **AnnC Caller ID**, then press **SELECT**.
4. Press \downarrow or \uparrow to highlight **Handset** or **Base**, then press **SELECT**.
5. Press \downarrow or \uparrow to choose **On** or **Off**, then press **SET** to save. You hear a confirmation tone.



note

- To use the caller ID announce feature, you must subscribe to caller ID service from your telephone service provider.
- Only the first four registered handsets will be able to use this feature.
- If the phone number of the incoming call matches the last 7 digits of a directory entry, the name will be announced as it appears in the entry.
- The phone number will be announced when the name is unknown, private or not provided. Only the last 11 numbers of a phone number is announced.
- No information will be announced if both the name and number are private, unknown or not provided.
- This feature is not supported with headsets.
- This feature does not announce information for call waiting calls.
- If both home and cell lines are ringing, only the caller ID information of the first ringing line will be announced.
- It takes at least 2 rings for the phone to receive caller ID information and announce it. If the phone is answered before the end of the second ring, it will not have time to announce the caller ID information.
- Pronunciation of names may vary with this feature. Not all names may be pronounced correctly.

Telephone settings

Website

You can use this feature to view the VTech website address.

1. Press **MENU** on the handset when it is not in use.
2. Press \downarrow or \uparrow to highlight **Website**, then press **SELECT**. The handset displays the VTech website.
3. Press **OK** to exit.



Home area code

If you dial local calls using only seven digits (area code not required), you can program your home area code so that when you receive a call within your local area, the telephone number is automatically stored without the area code in the caller ID log.

When you review the directory, call log or redial list, you can press # (pound key) repeatedly to show different dialing options before dialing.

To change the setting:

1. Press **MENU** on the handset when it is not in use.
2. Press \downarrow or \uparrow to highlight **Directory**, then press **SELECT**.
3. Press **OPTION** to choose **Home**.
4. Press \downarrow or \uparrow to highlight **Home area code**, then press **SELECT**. The handset displays **Only for 7 digits dialing from Caller ID log**.
5. Use the dialing keys to enter the desired home area code.
 - Press **MUTE/DELETE** to erase a digit.
 - Press and hold **MUTE/DELETE** to erase all digits.
 - Press \downarrow to move the cursor to the right or \leftarrow to the left.
6. Press **SET** to save. The handset displays **Area code will not show in Caller ID log**. You hear a confirmation tone.

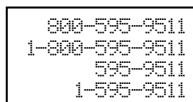

note

If, in the future, your telephone service provider requires you to dial 10 digits to make a local call (area code plus telephone number), you need to delete your home area code. With the home area code displayed, press **MUTE/DELETE** to delete the numbers, and then press **SET**. The home area code is now restored to its default setting of ___ (empty).

Telephone settings

Cell area code

Most cell phone entries are stored in a 10-digit format. If all of your cell phone entries are stored this way, you do not need to program your cell area code.

If your cell phone stores entries in a 7-digit format, we recommend that you program your cell area code so that your 7-digit directory entries can be dialed correctly using your home line. While reviewing an entry in the caller ID log or directory, you can press # (pound key) repeatedly to see different dialing options before you dial or store the number.

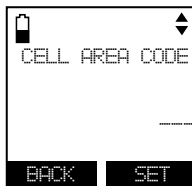
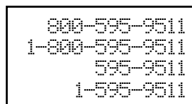

To change the setting:

1. Press **MENU** on the handset when it is not in use.
2. Press \vee or \wedge to highlight **Directory**, then press **SELECT**.
3. Press \vee or \wedge to highlight a desired downloaded directory, then press **OPTION**.
4. Press **SELECT** to choose **Cell area code**. The handset displays **Only for 7 digits dialing from Caller ID log**.
5. Use the dialing keys to enter the desired cell area code.
 - Press **MUTE/DELETE** to erase a digit.
 - Press and hold MUTE/DELETE to erase all digits.
 - Press \vee to move the cursor to the right or \wedge to the left.
6. Press **SET** to save. The handset displays **Area code will not show in Caller ID log**. You hear a confirmation tone.

Telephone settings

Telephone base settings

Telephone base ringer volume

Press ▲/VOL or ▼/VOL on the side of telephone base to adjust the ringer volume when the telephone is not in use. When you set the ringer volume to zero, the base ringer is off and the system announces, “Base ringer is off.”

Press ▼/VOL during an incoming call to mute the ringer temporarily.

note

See page 37 to set the handset ringer volume.

Answering system settings

Go to **Answering system settings** starting on page 82 for instructions on how to use a system handset to modify the answering system settings shown below.

Setting	Page
Answer on/off	82
Announcement (play, record and delete)	83-84
Call screening	85
Number of rings	86
Remote access code	87
Message alert tone	88
Recording time	88

Telephone operation

Make, answer or end a home call

Using a handset:

To make a home call:

1. Press **HOME/FLASH** or **📞**, then enter the telephone number.
2. Press **📞** on the headset to join the call. Hang up the handset at any time to leave the call and the headset continues the call.

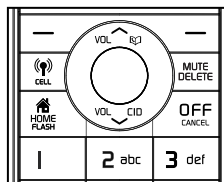

To predial a home call:

1. Enter the telephone number, then press **HOME/FLASH** or **📞**.
2. Press **📞** on the headset to join the call. Hang up the handset at any time to leave the call and the headset continues the call.

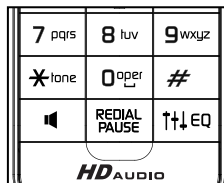

To answer a home call:

- Press **HOME/FLASH** or **📞**.
- Press **📞** on the headset.

To end a home call:

- Press **OFF/CANCEL** or put the handset in the telephone base or charger.
- Press **📞** on the headset or place the headset in the headset charger.

note

- The screen shows the elapsed time as you talk (in hours, minutes and seconds).
- When predialing (preview numbers before dialing), press **MUTE/DELETE** to backspace and delete; press and hold **REDIAL/PAUSE** to insert a dialing pause (a **p** appears).
- You cannot answer a home call using your connected cell phone.

Using a Bluetooth headset:

You can use a Bluetooth headset on home calls. However, you will need to stay within 30 feet from the telephone base to maintain the Bluetooth signal.

To answer a home call using a Bluetooth headset:

- Press the call key on your headset.

To end a home call you answered from a Bluetooth headset:

- Press the call key on your headset.

Telephone operation

Make, answer or end a home call (continued)

To transfer a call from a handset to a Bluetooth headset:

If you make or answer a home call on a handset, you can transfer the call to your Bluetooth headset. The handset remains active, but the handset earpiece and microphone are muted. If you hang up the handset, the call will end.

- Press **OPTION**.
- Press \vee or \wedge to choose **Use BT headset**, then press **SELECT** twice. The handset briefly displays **Transferring audio to Headset A** when the call is successfully transferred to the Bluetooth headset.

note

- If you answer a call from the Bluetooth headset, that call cannot be transferred to a handset.
- The handset will not show **Use BT headset** when the Bluetooth headset is already in use, or there are no active Bluetooth headsets on the device list.
- You cannot use a Bluetooth headset on cell calls.

To transfer a call from the headset back to the handset:

- Press **OPTION**, then press \vee or \wedge to highlight **Use handset** and then press **SELECT**.

To end a call that started at the handset:

- Press **OFF/CANCEL** or put the handset in the telephone base or charger.

note

- If you answer a call using a Bluetooth headset, and you lose the Bluetooth connection or the battery is depleted, the call will be lost.
- If you are using a Bluetooth headset for a call which is transferred from a handset, and you lose the Bluetooth connection or the battery of the headset is depleted, the call will be transferred back to the originating handset.

Call waiting on the home line

When you subscribe to call waiting service with your telephone service provider, you hear a beep if someone calls while you are already on a call.

- Press **HOME/FLASH** on the handset or **press and hold MUTE/FLASH** for two seconds on the headset to put your current call on hold and take the new call.
- Press **HOME/FLASH** on the handset or **press and hold MUTE/FLASH** for two seconds on the headset at any time to switch back and forth between calls.

Telephone operation

Make, answer or end a cell call

You can connect a maximum of two Bluetooth enabled cell phones to the telephone base, but only one cell phone can be used on a cell call at a time. All handsets can be used to make or answer calls on the cell phone line.

To make a cell call:

1. Press **(P)/CELL**.
2. Enter the telephone number, then press **DIAL**.
3. Press **Ⓜ** on the headset to join the call. Hang up the handset at any time to leave the call and the headset continues the call.

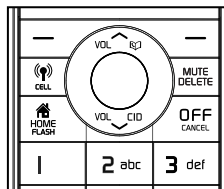

- OR -

1. Enter the telephone number, then press **(P)/CELL**.
2. Press **Ⓜ** on the headset to join the call. Hang up the handset at any time to leave the call and the headset continues the call.

If you have only one cell phone connected to the telephone base, it is automatically selected to make cell calls. If you have two cell phones connected to the telephone base, the telephone system prompts you to select a cell phone before you make a cell call.

To answer a cell call:

1. Press **(P)/CELL**.
2. Press **Ⓜ** on the headset to join the call. Hang up the handset at any time to leave the call and the headset continues the call.

note

You can also use your cell phone to answer the call. If you answer with your cell phone, it will disconnect from the telephone base.

To end a cell call:

- Press **OFF/CANCEL** or put the handset in the telephone base or charger.

Call waiting on the cell line

When you subscribe to call waiting service with your cell phone service provider, you hear a beep if someone calls while you are already on a call.

- Press **(P)/CELL** on the handset or press and hold **MUTE/FLASH** for two seconds on the headset to put your current call on hold and take the new call.
- Press **(P)/CELL** on the handset or press and hold **MUTE/FLASH** for two seconds on the headset at any time to switch back and forth between calls.

- OR -

- Press **SWAP** to switch.
- To switch back, press **OPTION**. Press **∨** or **∧** to choose **Swap**, and then press **SELECT**.

Telephone operation

Answer a cell call while on a home call

When you are on a home call and you receive an incoming cell call, you hear a beep, and **1** or **2** displays on the handset you are using. The telephone base and all other handsets ring.

To answer the incoming cell call:

- Press **CELL** on the handset. The home call is automatically placed on hold and all other handsets display **Home call on hold** and **Cell line in use** alternately.

To end the cell call:

- Press **OFF/CANCEL** on the handset. The home line is still on hold. All handsets display **Home call on hold**.

To resume the home call on hold:

- Press **HOME/FLASH** on the handset.

Cell phone voicemail

If you have voicemail service active on your cell phone, and you do not answer the incoming cell call, the call will be answered by your cell phone's voicemail. Contact your cell phone service provider for more information about voicemail service.

Answer a home call while on a cell call

If you are on a cell call and you receive an incoming home call, you will hear a beep and **HOME** displays on the handset you are using. The telephone base and all other handsets will ring.

To answer the incoming home call:

- Press **HOME/FLASH** on the handset. The cell call is automatically placed on hold and all other handsets display **Cell call on hold** and **Home line in use** alternately.

To end the home call:

- Press **OFF/CANCEL** on the handset. The cell line is still on hold. All handsets display **Cell call on hold**.

To resume the cell call on hold:

- Press **CELL** on the handset.

note

If you have turned on your answering system and you do not answer the incoming home call, the call will be answered by your answering system.

Telephone operation

Conference home and cell calls

When you have calls established on the home and cell lines, you can create a 3-way conference.

To conference both home and cell calls:

1. Press **OPTION**.
2. Press \vee or \wedge to highlight **Conference**.
3. Press **SELECT**. The handset displays **Lines now in conference**.

To select an option while on a conference call:

1. Press **OPTION**.
2. Press \vee or \wedge to highlight one of the following options:
 - **End Home line**
 - **End Cell line**
 - **End Conference**
 - **Directory**
 - **Caller ID log**
3. Press **SELECT**.

To end a conference call:

- Press **OFF/CANCEL** or put the handset back in the telephone base or charger.

- OR -

- Press **OPTION**, then press \vee or \wedge to highlight **End Conference**. Press **SELECT** to end the conference.

Using the home and cell lines together

- You can be on two different calls using the cell line and home line at the same time using two handsets.
- You cannot be on a call using the cell line and a Bluetooth headset via the home line at the same time. These are both Bluetooth devices and only one can be used at a time.
- If you are on a call using the cell line, you cannot join the call using your paired cell phone. However, you can join the call using another handset. Your cell phone is being used for the phone call so only features that are normally available during a call can be used.

Telephone operation

Handset speakerphone

During a call, press **☎** to switch between speakerphone and normal handset use.

Volume control

During a call, press **VOL/▲/Ⓜ** or **VOL/▼/CID** on the handset, or **+/-/VOLUME** on the side of the headset to adjust the listening volume. You hear an in-ear beep while adjusting. If you turn off the key tone, the in-ear beep will not be heard.

If this is a cell call and the volume is too loud or quiet, try changing the volume on your cell phone. On some cell phones, changing the volume on the cell phone effects your cell call volume on the **DS6472** handset.

Silence the ringer

When the telephone is ringing, you can temporarily silence the ringer of the handset or headset without disconnecting the call. The next call rings normally at the preset volume.

To silence the handset ringer:

- Press **SILENCE**, **OFF/CANCEL** or **MUTE/DELETE** on the handset and **Ringer muted** appears.

To silence the headset ringer:

- Press **MUTE/FLASH** on the headset.

To silence the telephone base ringer:

Press **▼/VOL** during an incoming call to mute the ringer temporarily.

Mute

The mute function turns off the microphone. You can hear the caller, but the caller cannot hear you.

On a handset:

- During a call, press **MUTE/DELETE** to turn off the microphone. The handset shows **Microphone off** briefly and **MUTE** appears until the mute function is turned off.
- Press **MUTE/DELETE** again to resume the conversation. The handset briefly shows **Microphone on**.

On a headset:

- During a call, press **MUTE/FLASH**. The headset announces, “*Mute on.*” The headset beeps every 30 seconds until the mute function is turned off.
- Press **MUTE/FLASH** again to resume the conversation. The headset announces, “*Mute off.*”

Telephone operation

Temporary tone dialing

If you have pulse (rotary) service only, you can switch from pulse to touch-tone dialing temporarily during a call. This is useful if you need to send touch-tone signals to access your telephone banking or long distance services.

During a call:

1. Press ***^{tone}**.
2. Use the dialing keys to enter the relevant number. The telephone sends touch-tone signals.
3. The telephone automatically returns to pulse dialing mode after you end the call.

Hold

You can place a home or cell call on hold. You will hear an alert tone if you have not taken the call off of hold after 14 minutes. You will hear another alert tone 30 seconds later. At 15 minutes on hold, the call on hold automatically disconnects.

To place a home call on hold:

- Press **HOLD**. **Home call on hold** appears and **🏠/HOME/FLASH** flashes.

To resume a home call on hold:

- Press **🏠/HOME/FLASH**.

To place a cell call on hold:

- Press **HOLD**. **Cell call on hold** appears and **📶/CELL** flashes.

To resume a cell call on hold:

- Press **📶/CELL**.

Handset/headset locator

This feature helps you find misplaced handsets and headset.

To start paging:

- Press **🔍/FIND HANDSET** on the telephone base when it is not in use. All idle handsets and headset ring; the handsets display **** Paging **** and the **🔍** light on the headset flashes in blue.

To end paging:

- Press **🔍/FIND HANDSET** on the telephone base.

- OR -

- Press **🏠/HOME/FLASH**, **📶/CELL**, **📞**, **PUSH TO TALK**, **REDIAL/PAUSE**, **↑↓/EQ** or any dialing key (**0-9**, **#** or ***^{tone}**) on the handset, or press **🔍** on the headset.

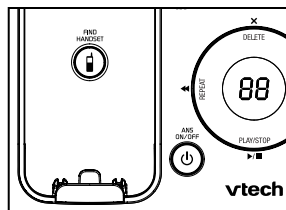

Telephone operation

Equalizer

The equalizer feature on the handset enables you to change the quality of the handset audio to best suit your hearing. While on a call, an intercom, a PTT session, or listening to a message or announcement, press **↑↓EQ** to select the equalizer setting **Treble 1**, **Treble 2**, **Bass** or **Natural** (the default setting) for the handset. You hear an in-ear beep while adjusting. If you turn off the key tone, the in-ear beep will not be heard. The current setting is shown on the handset for two seconds.

note

- The equalizer feature does not apply to the speakerphone on the telephone base or the connected Bluetooth headset.
- If you switch the call between the handset and the speakerphone by pressing **📞**, the audio setting remains unchanged.
- The current equalizer setting remains unchanged until a new setting is selected.

Transfer a call

While on an outside call, you can transfer the call from one handset to another.

1. Press **OPTION**, then press **SELECT** to highlight **Transfer**.
 - If you have two handsets, your handset displays **Transferring call to HANDSET X**. The destination handset rings and displays **Home Transfer from other handset**.
 - If you have three or more handsets, your handset displays **TRANSFER TO:** and a list of registered handsets. Press **∨** or **∧** to highlight a destination handset and then press **SELECT**. Your handset displays **Transferring call to HANDSET X**, or **Transferring call to all...** when you choose **All handsets**. The destination handset rings and displays **Home Transfer from HANDSET X** or **Home Transfer from HANDSET X to all**.
2. Your handset displays **Call transferred** when the other handset picks up the call. You hear a confirmation tone.

note

- If the destination handset does not answer within 30 seconds, the originating handset displays **No response to transfer** and rings. If the originating handset does not answer the call on hold within 30 seconds, the call will end automatically.

Telephone operation

Chain dialing

Use this feature to initiate a dialing sequence from numbers stored in the directory, caller ID log or redial while you are on a call.

Chain dialing can be useful if you wish to access other numbers (such as bank account numbers or access codes) from the directory, caller ID log or redial list.

To access a number in the directory while on a call:

1. Press **OPTION**.
2. Press \vee or \wedge to highlight **Directory**, then press **SELECT**.
3. Press \vee or \wedge to highlight a desired directory, then press **REVIEW**.
4. Press \vee or \wedge to scroll to the desired entry, or perform an alphabetical search (page 71).
5. Press **DIAL** to dial the displayed number.

To access a number in the caller ID log while on a call:

1. Press **OPTION**.
2. Press \vee or \wedge to highlight **Caller ID log**, then press **SELECT**.
3. Press \vee or \wedge to highlight a desired directory, then press **REVIEW**.
4. Press \vee or \wedge to scroll to the desired entry.
5. Press **DIAL** to dial the displayed number.

To access the redial list while on a call:

1. Press **REDIAL/PAUSE**.
2. Press \vee , \wedge or **REDIAL/PAUSE** repeatedly until the desired number displays, then press **DIAL** to dial the displayed number.

note

- You cannot edit a directory entry while on a call. For more details about the directory, see page 69.
- You cannot copy a caller ID log entry into the directory while on a call. For more details about caller ID log, see page 77.
- You can only view the numbers in the directory, caller ID log or redial while on a call and cannot erase any entries.
- While on a call, press **OFF/CANCEL** to exit the directory, caller ID log or redial list.

Telephone operation

Redial list

The redial list stores up to 10 of the most recently dialed numbers on each handset.

When there are already 10 entries, the oldest entry is deleted to make room for the new entry. Entries are shown in reverse chronological order.

Review the redial list

1. Press **REDIAL/PAUSE** when the handset is not in use.
2. Press \vee , \wedge or **REDIAL/PAUSE** to browse. You hear a double beep when you reach the beginning or end of the redial list.

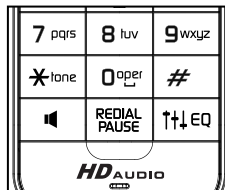

Dial a redial entry

1. Press **REDIAL/PAUSE** when the handset is not in use.
2. Press \vee , \wedge or **REDIAL/PAUSE** to browse until the desired number displays.
3. Press house icon /**HOME/FLASH** or speaker icon to use the home line.
- OR -
Press cell icon /**CELL** to use the cell line.

Telephone operation

Save a redial entry to the directory

1. Press **REDIAL/PAUSE** when the handset is not in use.
2. Press \vee , \wedge or **REDIAL/PAUSE** to select the desired number.
3. Press **SAVE**.
4. The handset displays **EDIT NUMBER**. Use the dialing keys to edit the number, if necessary.
 - Press **MUTE/DELETE** to erase a digit.
 - Press and hold **MUTE/DELETE** to erase all digits.
 - Press \vee to move the cursor to the right or \wedge to the left.
 - Press and hold **REDIAL/PAUSE** to insert a dialing pause (a **p** appears).
5. Press **NEXT**.
6. Press \wedge or \vee to highlight one of the following types:
 - Home
 - Cell
 - Work
 - Other
7. Press **NEXT**. The handset displays **ENTER NAME**. Use the dialing keys to enter a name.
 - Press **MUTE/DELETE** to erase a character.
 - Press and hold **MUTE/DELETE** to erase all characters.
 - Press \vee to move the cursor to the right or \wedge to the left.
8. Press **SAVE** and then **Saved** displays. You hear a confirmation tone.

Delete a redial entry

1. Press **REDIAL/PAUSE** when the handset is not in use.
2. Press \vee , \wedge or **REDIAL/PAUSE** to select the desired number.
3. Press **MUTE/DELETE** to delete the displayed number. You hear a confirmation tone.

Multiple handset use

Share an outside call

You can use up to four system handsets on an outside call at a time.

While on a call:

- Press **HOME/FLASH** or **⏻** on another handset, or **🔊** on the headset to join the call.

- OR -

- Press **OPTION** during an intercom call, then press **⏴** or **⏵** to highlight **Share call**. Press **SELECT**.

Intercom

Use the intercom feature for conversations between two system handsets, or a handset and a headset. Only one intercom call can be established at a time.

To initiate an intercom call:

1. Press **MENU** on the handset when it is not in use.
2. Press **⏴** or **⏵** to highlight **Intercom**, then press **SELECT**.
 - If you have two handsets, your handset displays **Calling other handset**. The destination handset rings and displays **Other handset is calling**.
 - If you have one handset and one headset, your handset displays **Calling HEADSET**.
 - If you have three or more handsets and/or headsets, your handset displays **INTERCOM** and a list of registered handsets.

Press **⏴** or **⏵** to highlight a destination handset or headset and then press **SELECT**. Your handset displays **Calling HANDSET X**, **Calling HEADSET X** or **Calling all handsets** when you choose **All handsets**.

- OR -

Use the dialing keys to enter a destination handset number (1-9 for handsets 1-9, ***tone** and **0** for handset 10, ***tone** and **1** for handset 11, ***tone** and **2** for handset 12, ***tone** and **#** for all handsets, **#** and **1** for handset 1 or **#** and **2** for handset 2).

The destination handset rings and displays **HANDSET X is calling**, or **HANDSET X is calling all** when you choose all handsets, or the headset earpiece rings and the **🔊** light flashes in blue.



Multiple handset use

Intercom (continued)

To answer an intercom call at the destination handset:

- Press **🏠/HOME/FLASH** or **🔊**. Both handsets show **Intercom**.
- Press **📞** on the headset. The originating handset displays **Intercom**.

To silence an intercom call:

- Press **OFF/CANCEL**, **MUTE/DELETE** or **SILENCE** on the destination handset. Its screen displays **Ringer muted** for a few seconds.

To end an intercom call:

- Press **OFF/CANCEL**, **END** or place either handset back in the telephone base or charger. Both handsets display **Intercom ended**.
- Press **📞** or place the headset in the headset charger. The originating handset displays **Intercom ended**.

note

- You can cancel the intercom call before it is answered by pressing **OFF/CANCEL** or **END** on your handset.
- If you are calling all devices, the quickest device will answer the intercom call.
- If the destination handset does not answer the intercom call within 100 seconds, is in the directory or caller ID log, or is out of range, the originating handset displays **No answer. Try again.** and returns to idle mode.

Answer an incoming call during an intercom call

When you receive an incoming home call during an intercom call, there is an alert tone and **Home Incoming call** and then the caller ID display on screens. The telephone base and all other handsets and headset ring.

- Press **🏠/HOME/FLASH** on the handset or press and hold **MUTE/DELETE** for two seconds on the headset to answer the home call. The intercom call ends automatically.
- Press **OFF/CANCEL** on the handset or press **📞** on the headset to end the intercom call without answering the incoming call. The telephone continues to ring.

When you receive an incoming cell call during an intercom call, there is an alert tone and **Cell Incoming call** and then the caller ID display on screens. The telephone base and all other handsets ring.

- Press **📶/CELL** on the handset or press and hold **MUTE/DELETE** for two seconds on the headset to answer the cell call. The intercom call ends automatically.
- Press **OFF/CANCEL** on the handset or press **📞** on the headset to end the intercom call without answering the incoming call. The telephone continues to ring.

Multiple handset use

Transfer a call using intercom

You can use the intercom feature to transfer an outside call to other system handsets or headset.

1. When on an outside call, press **OPTION**.
2. Press \vee or \wedge to highlight **Intercom**, then press **SELECT**. The call is automatically put on hold.
 - If you have one handset and one headset, your handset displays **Calling HEADSET**.
 - If you have two handsets, your handset displays **Calling other handset**. The destination handset rings and displays **Other handset is calling**.
 - If you have three or more handsets, your handset displays **INTERCOM** and a list of registered handsets.

Press \vee or \wedge to highlight a destination handset and then press **SELECT**. Your handset displays **Calling HANDSET X**, **Calling HEADSET X**, or **Calling all handsets** when you choose **All handsets**.

- OR -

Use the dialing keys to enter a destination handset number (1-9 for handsets 1-9, \star_{tone} and 0 for handset 10, \star_{tone} and 1 for handset 11, \star_{tone} and 2 for handset 12, \star_{tone} and # for all handsets, # and 1 for headset 1 or # and 2 for headset 2).

3. When the destination handset answers the intercom call, both handsets show **Intercom**.
4. From this intercom call, you have the following options:
 - You can transfer the call. Press **OPTION** and then press **SELECT** to choose **Transfer**. Your handset shows **Call transferred**. The other handset automatically connects to the outside call.
 - You can let the other handset join you on the outside call in a three-way conversation. Press **OPTION**. Press \vee or \wedge to highlight **Share call** on your handset, then press **SELECT**.
 - Either person can press the appropriate line key (\wedge /HOME/FLASH or \odot /CELL) on the handset to take the held outside call, or press **OFF/CANCEL** or **END** to end the intercom call (the outside call will



note

- If you want to cancel an intercom call and reconnect to the outside call before the destination handset answers, press **OFF/CANCEL** or **END** on the originating handset.
- If the destination handset does not answer the intercom call within 100 seconds, is in the directory or caller ID log, or is out of range, the originating handset displays **No answer. Try again.** and returns to the outside call.

Multiple handset use

Push-to-talk (PTT)

You can directly broadcast messages from one handset to the speakerphone of one or a group of handsets. Press and hold PUSH TO TALK to begin two-way communication. If only one handset is available or registered, the handset screen shows **PTT requires two handsets** when you press **PUSH TO TALK**.

- Only one handset can talk at a time. To do so, press and hold PUSH TO TALK while you are speaking.
- You must release **PUSH TO TALK**, so the other person can respond.
- Only one PTT session can be active at a time.
- While PTT is in use between handsets, other handsets cannot use the intercom feature.
- If you attempt to place a PTT call to another handset that is on an outside call or intercom call, or accessing the answering system, your handset displays **Not available at this time**.

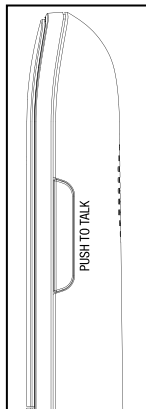

PTT on/off

You can turn PTT on or off on each handset.

To turn PTT on or off:

1. Press **PUSH TO TALK** when the handset is not in use. The **PUSH TO TALK** menu displays.
2. Press \downarrow or \uparrow to highlight **PTT On/Off**, then press **SELECT**.
3. Press \downarrow or \uparrow to choose **On** or **Off**, then press **SELECT** to save. You hear a confirmation tone.



note

When PTT is turned off, the handset shows **No Incoming PTT** while the phone is not in use.

Multiple handset use

PTT to a single handset

1. You have two ways to begin a PTT call:
 - If you have two handsets, press and hold **PUSH TO TALK** when handset is not in use.
 - If you have three or more handsets, press **PUSH TO TALK** when the handset is not in use. Then use the dialing keys to enter a handset number (1-9 for handsets 1-9, *^{tone} and **0** for handset 10, *^{tone} and **1** for handset 11 or *^{tone} and **2** for handset 12), or press **^** or **v** to scroll to the desired handset then press **SELECT**. Press **SELECT** or **PUSH TO TALK** to create the push-to-talk session.

Your handset displays **Connecting to HANDSET X...** for a few seconds. When the connection is made, both your and the destination handsets display **Press and hold [PTT] to talk** and beep once.

2. Press and hold **PUSH TO TALK** on your handset. A chirp indicates your microphone is on. Speak towards the handset. Your voice is broadcast to the destination handset. While you are speaking, the handset displays **PTT To HANDSET X** (X represents the destination handset number).
3. Release **PUSH TO TALK** after speaking. All handsets beep once again. After the handsets beep, you can press and hold **PUSH TO TALK** to continue speaking or the destination handsets can respond (see **Answer a PTT call** on page 67).
4. Press **OFF/CANCEL** or **END** to end the PTT call. The handset displays **Push to talk Ended** for a few seconds.

- OR -

Place the handset in the telephone base or charger to end the PTT call.

note

After **PUSH TO TALK** is released, the PTT call remains open for a short time. If no one presses **PUSH TO TALK** within 10 seconds, the PTT call ends automatically.

Multiple handset use

PTT to multiple handsets

When there are multiple handsets registered to the telephone system, PTT supports one-to-group calls. PTT supports a maximum of one-to-four calls when one to five handsets are registered, and a maximum of one-to-three calls when six or more handsets are registered. The first four registered handsets will be able to use this feature. Other handsets can only use PTT for one-to-one calls.

1. To begin a PTT call to multiple handsets:
 - Press and hold **PUSH TO TALK** when the handset is not in use.
 - If you have three or more handsets, press **PUSH TO TALK** when the handset is not in use. Press ***^{tone}** and **#**, or press **^** or **v** to highlight **All handsets** then press **SELECT** or **PUSH TO TALK**.

Your handset displays **Connecting to all handsets...** for a few seconds. When the connection is made, both your and the destination handsets display **Press and hold [PTT] to talk** and beep once.

2. Press and hold **PUSH TO TALK** on your handset. A chirp indicates your microphone is on. Speak towards the handset. Your voice is broadcast to the destination handset.
While you are speaking, the handset displays **PTT To handset: X** (**X** represents the destination handset; a maximum of four handset numbers appear).
3. Release **PUSH TO TALK** after speaking. All eligible handsets beep once again. After the handsets beep, you can press and hold **PUSH TO TALK** to continue speaking or the destination handsets can respond (see **Answer a PTT call** on page 67).
4. Press **OFF/CANCEL** or **END** to end the PTT call. The handset displays **Push to talk Ended** for a few seconds.

- OR -

Place the handset in the telephone base or charger to end the PTT call.

note

After **PUSH TO TALK** is released, the PTT call remains open for a short time. If no one presses **PUSH TO TALK** within 10 seconds, the PTT call ends automatically.

Multiple handset use

Answer a PTT call

You can respond to a PTT call whenever the speakerphone light is off, as described below.

1. When your handset receives a PTT call, the handset beeps and displays **Press and hold [PTT] to talk**.
2. When the other party is speaking, your speakerphone light is on, and your handset displays **PTT From HANDSET X To handset: Y** (X represents the originating handset and Y represents the destination handset; a maximum of four handset numbers appear).
3. When your speakerphone light is off and the handset displays **Press and hold [PTT] to talk**, press and hold **PUSH TO TALK** on your handset. When you hear a chirp, speak towards the handset.
 - While you are speaking, your handset displays **PTT To HANDSET X** (X represents the handset numbers of one or more destination handsets; a maximum of four handset numbers appear).
 - Your voice is broadcast to all destination handsets.

After speaking, release **PUSH TO TALK**. Your handset will beep. After the beep, if your speakerphone light is off, you can press and hold **PUSH TO TALK** to speak again or the destination handset can respond.

Change a one-to-one PTT to intercom call

You can convert a one-to-one PTT session to an intercom call.

1. When your handset displays **Press and hold [PTT] to talk**, press **INTCOM**. Your handset displays **Switch to Intercom?** Press **SELECT** to confirm.
 - If you have two handsets, your handset displays **Calling other handset**. The destination handset temporarily displays **Push to talk Ended** and then **Other handset is calling**.
 - If you have three or more handsets, your handset displays **Calling HANDSET Y** (Y represents the destination handset). The destination handset temporarily displays **Push to talk Ended** and then **Handset X is calling** (X represents the originating handset).
2. On the destination handset, press **HOME/FLASH** or **END** to answer the intercom call. Both handsets now display **Intercom**.
3. To end the intercom call, press **OFF/CANCEL**, **END**, or place the handset in the telephone base or charger. Both handsets display **Intercom ended**.

Multiple handset use

End a PTT call

- For a one-to-one PTT call, both the originating and destination handsets can end the PTT call.
- For a PTT call to multiple handsets, the originating handset can end the PTT call. If any one of the destination handsets leaves the PTT call, the call continues until all participants or the initiator hangs up.

To end or leave a PTT call:

Press **OFF/CANCEL**, **END**, or place the handset in the telephone base or charger. The handset displays **Push to talk Ended**.

note

After **PUSH TO TALK** is released, the PTT call remains open for a short time. If no one presses **PUSH TO TALK** within 10 seconds, the PTT call ends automatically.

Answer an incoming call during a PTT call

When you receive an incoming outside call during a PTT session, there is an alert tone. The PTT screen and the caller ID information display alternately.

- During a one-to-one PTT, press **HOME/FLASH** or **CELL** on the originating or destination handset. The PTT call ends automatically and the outside call is answered.
- During a PTT call to multiple handsets, press **HOME/FLASH** or **CELL** on the originating handset. The PTT call ends automatically and the outside call is answered.
- During a PTT call to multiple handsets, press **HOME/FLASH** or **CELL** on any one of the destination handsets and that handset answers the outside call. The PTT call continues for the rest of the PTT participants.
- To leave the PTT call without answering the incoming call, press **OFF/CANCEL**. The telephone continues to ring.

Make an outgoing call during a PTT call

- During a one-to-one PTT call, press **HOME/FLASH** or **CELL** to get a dial tone. The PTT call ends automatically.
- During a PTT call to multiple handsets, press **HOME/FLASH** or **CELL** on the originating handset. The PTT call ends automatically and you get a dial tone.
- During a PTT call to multiple handsets, press **HOME/FLASH** or **CELL** on any one of the destination handsets and that handset gets a dial tone. The PTT call continues for the rest of the PTT participants.

Directory

About the directory

Your phone directory consists of a home directory and up to four directories downloaded from cell phones. The home directory stores up to 200 entries with up to 30 digits for each phone number and 15 characters for each name. Each downloaded directory stores up to 1,500 entries with up to 30 digits for each phone number and 15 characters for each name.

- Directory entries are stored at the telephone base and shared by all system handsets. Any changes made on one handset apply to all.
- Only one handset can review the directory at a time. If another handset tries to enter the directory, it shows **Not available at this time**.
- When you access the directory with no records, the handset shows **Directory empty**.
- When the directory is full and you try to save an entry, the handset shows **Directory full**.
- When you try to save a number already stored in the directory, the handset shows **Already saved**.

All of the instructions on pages 70-75 for the directories apply to the home directory and all downloaded directories. Creating a new entry on page 70 only applies to the home directory.

You cannot create new entries in your downloaded directories from the **DS6472** handset. Entries must be downloaded from your cell phone (see **Download directory** on page 33).

Directory

Create a new entry in the home directory

1. Press **MENU** on the handset when it is not in use.
 2. Press \vee or \wedge to highlight **Directory**, then press **SELECT**.
 3. Press **OPTION** to select **Home**.
 4. Press \vee or \wedge to highlight **Add contact**, then press **SELECT**. The handset displays **ENTER NUMBER**.
 5. Use the dialing keys to enter a telephone number (up to 30 digits).
 - Press **MUTE/DELETE** to erase a digit.
 - Press and hold **MUTE/DELETE** to erase all digits.
 - Press \vee to move the cursor to the right or \wedge to the left.
 - Press and hold **REDIAL/PAUSE** to insert a dialing pause (a **p** appears).
- OR -
- Copy a number from the redial list.
- i. Press **REDIAL/PAUSE** and then \vee , \wedge or **REDIAL/PAUSE** to browse to the desired number.
 - ii. Press **INSERT** to copy the displayed number.
6. Press **NEXT**.
 7. Press \vee or \wedge to highlight one of the following types:
 - Home
 - Cell
 - Work
 - Other
 8. Press **NEXT**. The handset displays **ENTER NAME**.
 9. Use the dialing keys to enter the name (up to 15 characters). Additional key presses show other characters of that particular key. Press the key repeatedly until the desired character appears. The first character and the character after a space are automatically capitalized.
 - Press **MUTE/DELETE** to erase a character.
 - Press and hold **MUTE/DELETE** to erase all characters.
 - Press \vee to move the cursor to the right or \wedge to the left.
 10. Press **SAVE** and then the handset shows **Saved**. You hear a confirmation tone.

note

You cannot create new entries in your downloaded directories from your **DS6472** handsets. Entries must be downloaded from your cell phone (see **Download directory** on page 33).

Directory

Review the directory

Entries are sorted alphabetically.

To review the directory:

1. Press **VOL/** when the handset is not in use.
2. Press **∨** or **∧** to choose a directory, then press **REVIEW**.
3. Press **∨** or **∧** to browse.

- OR -

1. Press **MENU** on the handset when it is not in use.
2. Press **∨** or **∧** to highlight **Directory**, then press **SELECT**.
3. Press **∨** or **∧** to choose a directory, then press **REVIEW**.
4. Press **∨** or **∧** to browse.

- OR -

1. Press **OPTION** while on a call.
2. Press **∨** or **∧** to highlight **Directory**, then press **SELECT**.
3. Press **∨** or **∧** to choose a directory, then press **REVIEW**.
4. Press **∨** or **∧** to browse.

note

When the desired entry displays, press **#** (pound key) repeatedly to show different dialing options.

3-character alphabetical search

You can use the enhanced 3-character search to find your contacts quickly and efficiently.

To start a search:

1. Follow the steps in **Review the directory** above to enter the directory.
2. When an entry appears, use the dialing keys to enter the letters associated with the name. You can enter up to three letters for the search. If there is no name matching the letters entered, the next closest match in alphabetical order appears. If necessary, use **∨** or **∧** to browse.

note



The cursor automatically moves to the next position in two seconds after you enter a letter. If you do not enter another letter within two seconds, the

Directory

Dial a directory entry

You can dial a directory entry on either a home or cell line.

To dial a directory entry:

1. Search for the desired entry in the directory (see **Review the directory** or **3-character alphabetical search** on page 71).
2. When the desired entry appears, press # (pound key) repeatedly to show different dialing options.
3. When the displayed number is in the correct format, press /HOME/FLASH or  to use the home line, or /CELL to use the cell line.

800-595-9511
1-800-595-9511
595-9511
1-595-9511

Edit a directory entry

You may edit any directory entry. However, be aware that if you download from a cell phone again, the directory will be erased and replaced with the current cell phone directory. If you have edited the downloaded entries on the **DS6472**, those changes will be lost.

1. Search for the desired entry in the directory (see **Review the directory** or **3-character alphabetical search** on page 71).
2. When the desired entry appears, press **EDIT**. The handset shows **EDIT NUMBER**.
3. Use the dialing keys to edit the number.
 - Press **MUTE/DELETE** to erase a digit.
 - Press and hold **MUTE/DELETE** to erase all digits.
 - Press \vee to move the cursor to the right or \wedge to the left.
 - Press and hold **REDIAL/PAUSE** to insert a dialing pause (a **p** appears).
4. Press **NEXT**.
5. Press \wedge or \vee to highlight one of the following types:
 - Home
 - Cell
 - Work
 - Other
6. Press **NEXT**. The handset displays **EDIT NAME**.
7. Use the dialing keys to edit the name.
 - Press **MUTE/DELETE** to erase a character.
 - Press and hold **MUTE/DELETE** to erase all characters.
 - Press \vee to move the cursor to the right or \wedge to the left.
8. Press **SAVE** and then the handset shows **Saved**.

Directory

Edit the type of a directory entry

If you only want to edit the type of a directory entry:

1. Search for the desired entry in the directory (see **Review the directory** or **3-character alphabetical search** on page 71).
2. When the desired entry appears, press **LABEL**. Enter the corresponding shortcut keys shown in the below table.

Type:	Press:
Home	1
Cell	2
Work	3
Other	4

- OR -

Press **CLEAR** to erase the assigned label.

Delete a directory entry

Once a directory entry is deleted, it cannot be retrieved.

To delete an entry:

1. Search for the desired entry in the directory (see **Review the directory** or **3-character alphabetical search** on page 71).
2. When the desired entry appears, press **MUTE/DELETE**. The handset displays **Delete contact?** and the name of the entry. Press **YES** to confirm.
3. The handset displays **Contact deleted** and then the next alphabetical entry in the directory. You hear a confirmation tone.

Remove a downloaded directory

1. Search for a desired downloaded directory in the directory menu (see **Review the directory** on page 71).
2. When the desired downloaded directory is chosen, press **OPTION**, then press **∨** or **∧** to highlight **Remove dir**.
3. Press **SELECT**. The handset displays **Directory CELL PHONE A will be erased**. Press **YES** to confirm.
4. The handset displays **Erasing directory...** and then **Directory removed**. You hear a confirmation tone.

Directory

Speed dial

You can copy 10 of your directory entries to the speed dial slots (0-9). The speed dial entries are shared by all handsets.



Assign a speed dial slot

1. Press **MENU** on handset when it is not in use.
2. Press \vee or \wedge to highlight **Directory**, then press **SELECT**.
3. Press \vee or \wedge to highlight **Speed dial**, then press **REVIEW**.
4. Press \vee or \wedge to highlight an empty slot, then press **ASSIGN**.
5. Press \vee or \wedge to highlight the desired directory, then press **REVIEW**.
6. Search for the desired entry in the directory (see **Review the directory** or **3-character alphabetical search** on page 71). When the desired entry appears, press **ASSIGN**. You hear a confirmation tone.

Reassign a speed dial slot

1. Press **MENU** on handset when it is not in use.
2. Press \vee or \wedge to highlight **Directory**, then press **SELECT**.
3. Press \vee or \wedge to highlight **Speed dial**, then press **REVIEW**.
4. Press \vee or \wedge to highlight the desired slot.
5. Press **ASSIGN**. The handset displays the directory at the current assigned entry.
6. Search for the desired entry in the directory (see **Review the directory** or **3-character alphabetical search** on page 71). When the desired entry appears, press **ASSIGN**.
7. The handset displays **Entry B replaces Entry A Accept?** Press **YES** to confirm. You hear a confirmation tone.

Dial a speed dial entry

1. Press and hold a desired speed dial slot (0-9).
2. Press /HOME/FLASH or  to use the home line, or /CELL to use the cell line.

Directory

Delete a speed dial entry

1. Press **MENU** on handset when it is not in use.
2. Press \vee or \wedge to highlight **Directory**, then press **SELECT**.
3. Press \vee or \wedge to highlight **Speed dial**, then press **REVIEW**.
4. Press \vee or \wedge to highlight an assigned slot, then press **MUTE/DELETE**.
5. The handset displays **Delete Entry A Speed dial assignment?**
Press **YES** to confirm. You hear a confirmation tone.

note

Deleting speed dial entries does not affect the directory entries.

Caller ID

About caller ID

This product supports caller ID services provided by most telephone service providers. Depending on your service subscription, you may see the caller's number, or the caller's name and number from the telephone service provider after the first or second ring. Caller ID from the home line allows you to see the name, number, date and time of the incoming calls. The caller ID may appear differently if the caller is matched to a directory entry (see **Memory match** on page 77).

Information about caller ID with call waiting

Caller ID with call waiting lets you see the name and telephone number of the caller before answering the telephone, even while on another call.

It may be necessary to change your telephone service to use this feature. Contact your telephone service provider and cell phone service provider if:

- You have both caller ID and call waiting, but as separate services (you may need to combine these services).
- You have only caller ID service, or only call waiting service.
- You do not subscribe to any caller ID or call waiting services.

There are fees for caller ID services. In addition, services may not be available in all areas.

This product can provide information only if both you and the caller are in areas offering caller ID service and if both telephone service providers use compatible equipment. The time and date are sent by your telephone service provider along with the call information.

You can use this product with regular caller ID service, or you can use this product's other features without subscribing to either caller ID or combined caller ID with call waiting service.

Caller ID

Caller ID history

If you subscribe to caller ID service provided by your telephone service provider and/or cell phone service provider, information about each caller appears after the first or second ring. If you answer a call before the caller information appears on the screen, it will not be saved in the caller ID log.

- The home line and each cell phone paired to the **DS6472** have their own caller ID log.
- The caller ID log stores up to 50 entries. Each entry has up to 15 digits for the phone number and 15 characters for the name. If the name has more than 15 characters, only the first 15 characters are shown and saved in the caller ID log. If the phone number has more than 15 digits, only the last 15 digits are shown and saved in the caller ID log.
- You can review, redial, and copy an entry into the directory.
- Entries are in reverse chronological order.
- When the caller ID log is full, the oldest entry is deleted to make room for new incoming call information.
- **XX Missed calls** shows when there are new caller ID log entries that have not been reviewed.
- **Caller ID log empty** shows when you access the caller ID log with no records.
- Only one handset can review the caller ID log at a time. If a handset tries to enter the caller ID log while another handset is already in it, **Not available at this time** appears.

note

The caller ID information may not be available for every incoming call. The callers may intentionally block their names and/or telephone numbers.

Memory match

If the last seven digits of the incoming telephone number is an exact match with a telephone number in your directory, the name that appears on the screen matches the corresponding name in your directory.

For example, if Elizabeth Jones calls, her name appears as Liz if this is how you entered it into your directory.

note

The number you see on your caller ID is in the format sent by the telephone service provider. It usually delivers 10-digit telephone numbers (area code plus telephone number). If the last seven digits of the incoming telephone number does not match a number in your directory, the name appears as it is delivered by the telephone service provider.

Caller ID

Review the caller ID log

1. Press **VOL** **↓**/**↑**/**CID** when the handset is not in use.
2. Press **↓** or **↑** to highlight the desired line (home or cell), then press **REVIEW**.
3. Press **↓** or **↑** to browse.

- OR -

1. Press **MENU** on the handset when it is not in use, or press **OPTION** while on a call.
 2. Press **↓** or **↑** to highlight **Caller ID log**, then press **SELECT**.
 3. Press **↓** or **↑** to highlight the desired line (home or cell), then press **REVIEW**.
 4. Press **↓** or **↑** to browse.
- The name and telephone number (if available), date and time of all incoming calls are shown.
 - You hear a double beep when you reach the beginning or end of the caller ID log.

Caller ID

View dialing options

Although the caller ID log entries received have 10 digits (the area code plus the seven-digit number), in some areas, you may need to dial only the seven digits, or 1 plus the seven digits, or 1 plus the area code plus the seven digits. You can change the number of digits that you dial from the caller ID log or store to the directory.

While reviewing the caller ID log, press **#** (pound key) repeatedly to display different dialing options for local and long distance numbers before dialing or saving the telephone number in the directory.

Press **1** repeatedly if you need to add or remove 1 in front of the telephone number before dialing or saving it in the directory.

When the number is displayed in the correct format for dialing, press **HOME/FLASH**, **END CALL** or **CELL** to dial.

Press # →

800-595-9511
1-800-595-9511
595-9511
1-595-9511

Press 1 →

1-800-595-9511
800-595-9511

Press 1 →

1-595-9511
595-9511

Dial a caller ID log entry

1. Search for the desired entry in the caller ID log (see **Review the caller ID log** on page 78).
2. When the desired entry appears and is in the correct format for dialing, press **HOME/FLASH** or **END CALL** to use the home line, or **CELL** to use the cell line.

Caller ID

Save a caller ID log entry to the directory

Caller ID log entries can only be saved to the **Home** directory.

1. Select a desired entry in the caller ID log (see **Review the caller ID log** on page 78).
2. When the desired entry appears, press **#** (pound key) repeatedly to show different dialing options.
3. When the number is in the correct format, press **SAVE**. The handset shows **EDIT NUMBER**.
4. Use the dialing keys to edit the number.
 - Press **MUTE/DELETE** to erase a digit.
 - Press and hold **MUTE/DELETE** to erase all digits.
 - Press **∨** to move the cursor to the right or **∧** to the left.
 - Press and hold **REDIAL/PAUSE** to insert a dialing pause (a **p** appears).
5. Press **NEXT**.
6. Press **∧** or **∨** to highlight one of the following types:
 - Home
 - Cell
 - Work
 - Other
7. Press **NEXT**. The handset displays **EDIT NAME**.
8. Use the dialing keys to edit the name.
 - Press **MUTE/DELETE** to erase a character.
 - Press and hold **MUTE/DELETE** to erase all characters.
 - Press **∨** to move the cursor to the right or **∧** to the left.
 - Press ***^{tone}** to toggle the name order. For example, Mike Smith becomes Smith Mike when you press ***^{tone}**.
9. Press **SAVE** and then the handset shows **Saved**. You hear a confirmation tone.

note

- If the name received from the telephone service provider is all in capital letters, the first letter of every word remains a capital letter. However, the next letter after the prefix “Mac”, “Mc”, or “O”, is kept as a capital letter. For example, the “D” in “MacDonald” is kept as a capital letter.
- When you try to save a caller ID entry without any caller ID information, the handset displays **Unable to save**.

Caller ID

Delete from the caller ID log

To delete a single entry:

1. Select a desired entry in the caller ID log (see **Review the caller ID log** on page 78).
2. When the desired entry appears, press **MUTE/DELETE**. The handset shows the previous caller ID log entry. You hear a confirmation tone.

To delete all entries:

1. Press **VOL~/CID** when the handset is not in use.
2. Press **ERASE**. If you choose the home caller ID log, the handset displays **Delete all Home Calls?** If you choose a cell phone caller ID log, the handset displays **Delete all Cell phone A calls?** Press **YES** to confirm. You hear a confirmation tone.

- OR -

1. Press **MENU** on the handset when it is not in use.
2. Press **∨** or **∧** to highlight **Caller ID log**, then press **SELECT**.
3. Press **ERASE**. If you choose the home caller ID log, the handset displays **Delete all Home Calls?** If you choose a cell phone caller ID log, the handset displays **Delete all Cell phone A calls?** Press **YES** to confirm. You hear a confirmation tone.

Caller ID log display screen messages

There are occasions that other information are shown instead of caller ID information.

Displays:	When:
Private name	The caller is blocking the name.
Private number	The caller is blocking the telephone number.
Private caller	The caller is blocking the name and number.
Unknown name	This caller's name is unavailable.
Unknown number	This caller's number is unavailable.
Unknown caller	No information is available about this caller.
Long distance or L (before the caller's number)	It is a long distance call.

Answering system settings

Answer on/off

If you turn the answering system on, it answers calls and records messages only on the home line. If your paired cell phone has voicemail, callers can leave messages with that voicemail service.

If your answering system is turned off and you change any of its settings, the answering system automatically turns on again and the handset displays **Calls will be answered.**

When the answering system is turned on, the **ANS ON/OFF** light on the telephone base is on and the handsets display **ANS ON.**

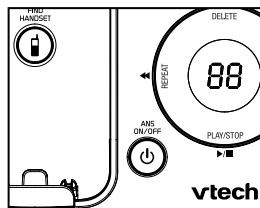

To turn the answering system on or off:

Using the telephone base:

- Press **ANS ON/OFF** to turn the answering system on or off. When the answering system is turned on, it announces, *"Calls will be answered."* When the answering system is turned off, it announces, *"Calls will not be answered."*

note

- If there is no remaining recording time, the answering system announces, *"Memory is full. Calls will not be answered,"* and cannot be turned on.
- If the total recording time is less than three minutes, the answering system announces, *"Less than three minutes to record."*
- If the answering system is off, you may press **ANS ON** to turn it on when there is an incoming call. The answering system answers the call immediately if there is remaining recording time.

Using a handset:

1. Press **MENU** on the handset when it is not in use.
2. Press **↓** or **↑** to highlight **Answering sys**, then press **SELECT**.
3. Press **↓** or **↑** to highlight **Answer ON/OFF**, then press **SELECT**.
4. Press **↓** or **↑** to choose **On** or **Off**, then press **SET** to save. You hear a confirmation tone.

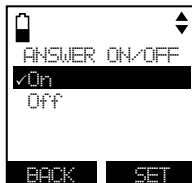
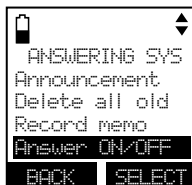

Answering system settings

Announcement

The telephone is preset with a greeting that answers calls with *“Hello, please leave a message after the tone.”* You can use this preset announcement, or replace it with your own.

Play your announcement

1. Press **MENU** on the handset when it is not in use.
2. Press **∨** or **∧** to highlight **Answering sys**, then press **SELECT**.
3. Press **SELECT** to choose **Announcement**.
4. The handset displays **ANNOUNCEMENT**, press **PLAY**.



Record your own announcement

1. Press **MENU** on the handset when it is not in use.
2. Press **∨** or **∧** to choose **Answering sys**, then press **SELECT**.
3. Press **SELECT** to choose **Announcement**.
4. The handset displays **ANNOUNCEMENT**, press **RECORD**.
5. The handset announces, *“Record after the tone. Press STOP when you are done.”* After the tone, speak towards the handset microphone.
6. Press **STOP** when you finish recording.
7. The handset automatically plays back the newly recorded announcement. Press **STOP** to stop the playback at any time. After the announcement playback, press **PLAY** to replay the recorded announcement, or **RECORD** to record again if desired.



note

- Your announcement can be up to 90 seconds in length.
- Announcements shorter than two seconds will not be recorded.

Answering system settings

Delete your announcement

1. Press **MENU** on the handset when it is not in use.
2. Press \vee or \wedge to choose **Answering sys**, then press **SELECT**.
3. Press **SELECT** to choose **Announcement**.
4. The handset displays **ANNOUNCEMENT**, press **PLAY** to play the announcement.
5. While the announcement is playing, press **DELETE** to delete your own recorded announcement. The handset displays **Reset Announcement to default?** Press **YES** to confirm. You hear a confirmation tone.

**note**

When your announcement is deleted, calls are answered with the default announcement.

Answering system settings

Answering system setup

In the answering system setup menu, you can change the settings for call screening, number of rings, remote access code, message alert tone and recording time.

Call screening

Use this feature to choose whether incoming messages are broadcast from the telephone base speaker when they are being recorded. While monitoring an incoming message, you can press **HOME/FLASH** or **END CALL** on the handset to answer the call.

To change the setting:

1. Press **MENU** on the handset when it is not in use.
2. Press **DOWN** or **UP** to highlight **Answering sys**, then press **SELECT**.
3. Press **DOWN** or **UP** to highlight **Ans sys setup**, then press **SELECT**.
4. Press **SELECT** to choose **Call screening**.
5. Press **DOWN** or **UP** to choose **On** or **Off**, then press **SET** to save. You hear a confirmation tone.

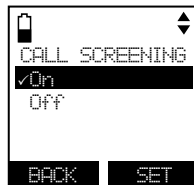
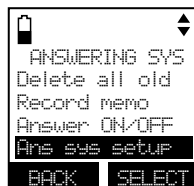

Answering system settings

Number of rings

When the answering system is turned on, it answers all incoming home calls after the number of rings set. You can choose from two, three, four, five or six rings; or toll saver. With toll saver selected, the answering system answers after two rings when you have new messages, and after four rings when you have no new messages. This enables you to check for new messages and avoid paying unnecessary long distance charges if you are calling from outside of your local area. The default number of rings is four.

To change the setting:

1. Press **MENU** on the handset when it is not in use.
2. Press \vee or \wedge to highlight **Answering sys**, then press **SELECT**.
3. Press \vee or \wedge to highlight **Ans sys setup**, then press **SELECT**.
4. Press \vee or \wedge to highlight **# of rings**, then press **SELECT**.
5. Press \vee or \wedge to choose from **6, 5, 4, 3, 2** or **Toll saver**, then press **SET** to save. You hear a confirmation tone.

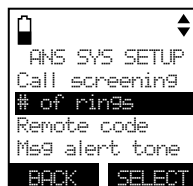

note

If you set the number of rings that the answering system answers calls as 3 rings, the answering system may not have enough time to announce the caller's full information.

Answering system settings

Remote access code

A two-digit security code is required to access the answering system remotely from any touch tone telephone. The preset code is **19**. You can change the code to any number from **00** to **99**.

To change the setting:

1. Press **MENU** on the handset when it is not in use.
2. Press \vee or \wedge to highlight **Answering sys**, then press **SELECT**.
3. Press \vee or \wedge to highlight **Ans sys setup**, then press **SELECT**.
4. Press \vee or \wedge to highlight **Remote code**, then press **SELECT**.
5. Use the dialing keys (**0-9**) to enter a two-digit number, then press **SET** to save. You hear a confirmation tone.
 - Press **MUTE/DELETE** to erase a digit.
 - Press and hold **MUTE/DELETE** to erase all digits.
 - Press \vee to move the cursor to the right or \wedge to the left.



Answering system settings

Message alert tone

When the answering system is turned on, the telephone beeps every 10 seconds to alert you of new messages. The tone stops when all new messages have been reviewed. The message alert tone is preset to off.

To change the setting:

1. Press **MENU** on the handset when it is not in use.
2. Press \downarrow or \uparrow to highlight **Answering sys**, then press **SELECT**.
3. Press \downarrow or \uparrow to highlight **Ans sys setup**, then press **SELECT**.
4. Press \downarrow or \uparrow to highlight **Msg alert tone**, then press **SELECT**.
5. Press \downarrow or \uparrow to choose from **On** or **Off**, then press **SET** to save. You hear a confirmation tone.



note

You cannot set the message alert tone when another handset or the telephone base is accessing the answering system.

Recording time

You can set the recording time limit for each incoming message. The default setting is three minutes.

To change the setting:

1. Press **MENU** on the handset when it is not in use.
2. Press \uparrow or \downarrow to highlight **Answering sys**, then press **SELECT**.
3. Press \uparrow or \downarrow to highlight **Ans sys setup**, then press **SELECT**.
4. Press \uparrow or \downarrow to highlight **Recording time**, then press **SELECT**.
5. Press \uparrow or \downarrow to choose from **3 minutes**, **2 minutes**, or **1 minute**, then press **SET** to save. You hear a confirmation tone.



Answering system operation

Answering system and voicemail indicators

Your telephone has separate indicators for two different types of voice messages: those left on its built-in answering system and those left at your service provider's voicemail (fees may apply). Your telephone's built-in answering system messages and voicemail messages are separate. Each alerts you to new messages differently.

- If **OO** and **XX New messages** display on the handsets and the message window on the telephone base flashes, there are new messages in the built-in answering system, press **PLAY/STOP/▶/■** on the telephone base. To listen to messages with a handset, see **To play messages with a handset** on page 92.
- If **☑** and **New voicemail** display on the handsets, your telephone service provider is indicating that it has new voicemail for you. To listen to your voicemail, you typically dial an access number provided by your telephone service provider, followed by a security code or PIN.

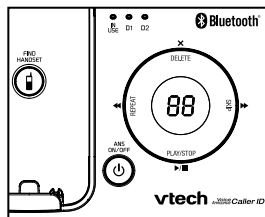

Some service providers bundle or combine multiple services like voicemail and call waiting, so you may not be aware that you have voicemail. To check what services you have and how to access them, contact your telephone service provider.

To use your voicemail service rather than your answering system, turn off your answering system. To use your answering system rather than your voicemail service, contact your telephone service provider to deactivate your voicemail service.

Using the answering system and voicemail together

You can use your telephone answering system and voicemail together by setting your built-in answering system to answer before voicemail answers. To learn how to program your voicemail settings, contact your telephone service provider. If you are on a call, or if the answering system is busy recording a message and you receive another call, the second caller can leave a voicemail message.

Set your answering system to answer calls at least two rings earlier than your voicemail is set to answer. For example, if your voicemail answers after six rings, set your answering system to answer after four rings. Some voicemail providers may program the delay before answering calls in seconds instead of rings. In this case, allow six seconds per ring when determining the appropriate setting.

Answering system operation

Message capacity

The answering system can record and store up to 99 messages. Each message can be up to three minutes depending on the message length set (see **Recording time** on page 88). The total storage capacity for the announcement, messages and memos is approximately 11 minutes. The actual recording time depends on individual message characteristics. Messages remain available for replay until you delete them.

Voice prompts

The system provides voice prompts to guide you through the setup procedures at the telephone base, message playback, remote access and recording outgoing announcements.

Call screening

Call screening at the telephone base:

If the answering system and call screening are on (see **Call screening** on page 85), the announcement and the incoming message broadcast at the telephone base while the call is answered by the answering system.

Options while a message is being recorded:

- Press **▲/VOL** or **▼/VOL** on the telephone base to adjust the call screening volume.
- Press **PLAY/STOP/▶/■** to temporarily silence the call screening.
- Press **PLAY/STOP/▶/■** to temporarily turn on or off call screening.

Call screening at the handset:

If the answering system is on and your answering system is recording a message, press **SCREEN** to screen the call on your handset and the screen displays the caller ID information. If you do not subscribe to caller ID service, the handset shows **Incoming call**.

note

The call screening setting does not affect the call screening on the handset.

Call intercept

If you want to talk to the person whose message is being recorded, press **▲/HOME/FLASH** or **■** on the handset.

Answering system operation

Temporarily turning off the message alert tone

If the message alert tone is turned on, the telephone base beeps every 10 seconds when there are new or missed messages. Pressing any telephone base key (except **FIND HANDSET**) temporarily silences the message alert tone.

If you press **DELETE/X** when in idle mode to temporarily turn off the message alert tone, there is a voice prompt directing you to press **DELETE/X** again to delete all old messages. The message alert tone is temporarily off. Only press **DELETE/X** a second time if you wish to erase all old messages in your answering system.

The message alert tone resumes when you receive a new message.

Message playback

On the telephone base, if you have new messages, the telephone plays only the new messages (oldest first). If there are no new messages, the telephone plays back all messages (oldest first).

On the handset, if you have both new and old messages, you can play either new or old messages. The caller ID information displays on the handset screen when you play messages and you can call back the caller.

When playback begins, the handset displays the message status, caller ID information, and time and date of the message recorded. You hear the total number of messages followed by the day and time of the message. After the last message, the telephone announces, "End of messages," and the handset displays **End of messages**.



To play messages with the telephone base:

1. Press **PLAY/STOP/▶/■** to listen to messages.

Options during playback:

- Press **▲/VOL** or **▼/VOL** to adjust the speaker volume.
- Press **SKIP/▶▶** to skip to the next message.
- Press **REPEAT/◀◀** to repeat the message currently playing. Press **REPEAT/◀◀** twice to listen to the previous message.
- Press **DELETE/X** to delete the current message. The system advances to the next message.
- Press **PLAY/STOP/▶/■** to stop.

Answering system operation

Message playback (continued)

To play messages with a handset:

1. Press **MENU** to show the menu when the handset is not in use.
2. Press **SELECT** to choose **Play messages**. If you have either new or old messages, the messages play automatically. If you have both new and old messages:
 - To play new messages, press **SELECT** to select **Play new msgs**.
 - To play old messages, press **▲/VOL** or **▼/VOL** to highlight **Play old msgs**, then press **SELECT**.

When the handset is playing a message, its screen shows the caller's name or number. If the caller's information is unavailable, the handset shows **No caller info**.

Options during playback:

- Press **VOL/▲** or **VOL/▼/CID** to adjust the speaker volume.
- Press **🔊** to play the messages through the handset earpiece.
- Press **SKIP** to skip the message summary or to the next message.
- Press **REPEAT** to repeat the message currently playing.
- Press **REPEAT** twice to playback the previous message.
- Press **OFF/CANCEL** to stop.
- Press **MUTE/DELETE** to delete the current message. The handset displays **Message deleted** briefly and the system advances to the next message.
- Press **↑↓EQ** to adjust the handset message playback audio quality.
- Press **2** to pause the playback and show the caller ID information. Press **🏠/HOME/FLASH**, **DIAL** or **🔊** to use the home line, or press **📶/CELL** to use the cell line to call back the caller. Press **OFF/CANCEL** or **BACK** to resume the playback. If you do not call back within 10 seconds, message playback resumes.
- Press **🏠/HOME/FLASH** or **📶/CELL** to pause the message playback. The handset displays **Call back?** with the caller ID information. Press **YES** to call back the caller, or **NO** to resume the message playback.

note

- When the answering system has less than three minutes of recording time left, it announces, "*Less than three minutes to record.*" and the handset displays **Rec mem low**.
- When the telephone is not in use, if **F** and the number of messages are flashing alternately in the message window, or the handset displays **Rec mem full**, the memory is full. Delete some messages to make room for more.

Answering system operation

Delete all old messages

Using the telephone base:

Press **DELETE/X** when the phone is not in use. The telephone announces, "To delete all old messages, press **DELETE** again." Press **DELETE/X** again. All previously heard messages are erased and the telephone announces, "All old messages deleted."

Using a handset:

1. Press **MENU** on the handset when it is not in use.
2. Press \vee or \wedge to highlight **Answering sys**, then press **SELECT**.
3. Press \vee or \wedge to highlight **Delete all old**, then press **SELECT**.
4. The handset displays **Delete all old messages?** Press **YES** to confirm.
5. The handset displays **Deleting...** and then **All old messages deleted!** You hear a confirmation tone.

note

You can only delete old messages, which are messages you have played.

Record and play memos

Memos are your own recorded messages used as reminders for yourself or others using the same answering system. You can record your own memos using a system handset. Play and delete them the same way as incoming messages.

To record a memo:

1. Press **MENU** on the handset when it is not in use.
2. Press \vee or \wedge to highlight **Answering sys**, then press **SELECT**.
3. Press \vee or \wedge to highlight **Record memo**, then press **SELECT**.
4. The system announces, "Record after the tone. Press **STOP** when you are done." After the tone, speak towards the microphone.
5. Press **STOP** when you finish recording. The handset announces, "Recorded," and then returns to the previous menu.

note

- The system announces "Memory is full." **Memory full** displays if you record a memo when the memory is full.
- Each memo can be up to four minutes in length.
- Memos shorter than two seconds are not recorded.

Answering system operation

Message window displays

Window display	Description
0	No messages.
0 (flashing)	The time and date need to be set.
1-99	Total number of old messages and memos recorded. The message number currently playing.
0-99 (flashing)	When time and date are not set, it flashes 0, the total number of new messages recorded, or total number of old messages recorded. The telephone base may have lost and regained power. The clock needs to be set.
1-99 & F (alternating)	The answering system memory is full with total number of messages recorded.
1-8	The telephone base speaker volume level while adjusting.
0-6	The telephone base ringer level while adjusting.
— —	The system is answering a call, or recording a memo or announcement. The telephone is being accessed remotely. The answering system is being programmed.

Answering system operation

Remote access

A two-digit security code is required to access the answering system remotely from any touch-tone telephone. The preset code is **19**. See **Remote access code** on page 87 to change it.

1. Dial your telephone number from any touch-tone telephone.
2. When the system plays the announcement, enter the two-digit security code.
3. You can also enter one of the following remote commands

Command	Function
1	Play all messages.
2	Play only new messages.
3	Delete the current message (during playback).
33	Delete all old messages.
4	Repeat the current message (during playback).
44	Play the previous message.
5	Stop.
*5	Hear a list of remote commands.
6	Skip to the next message (during playback).
*7	Record a new announcement.
8	Hang up the call
0	Turn the answering system on or off.

4. Hang up or press **8** to end the call.

note

- If you do not press any keys after you enter the remote access code, all new messages play. If there are no new messages, all old messages play.
- Once the new messages have played, the telephone announces the help menu options. If you do not press any key within 20 seconds, the remote access call automatically disconnects.
- When the answering system is turned off, the telephone answers after 10 rings, and announces, *"Please enter your remote access code."*
- When the memory is full, the answering system answers incoming calls after 10 rings and announces, *"Memory is full. Enter the remote access code."*

Appendix

Display screen messages

Add device failed	The Bluetooth device failed to pair to the telephone base.
Already saved	The telephone number entered is already stored in the directory.
Area code will not show in Caller ID log	The home area code you saved will not be shown in caller ID log.
Bluetooth headset in use. Cellular not available.	You are trying to make a cell call while the Bluetooth headset is in use.
Bluetooth system busy	You are trying to make a cell call or access the Bluetooth menu when the Bluetooth link is already being used.
Caller ID log empty	There are no caller ID log entries.
Caller ID won't be announced.	The ringer volume on the handset is turned off so no caller ID information will be announced for incoming calls.
Calling all handsets (for models with more than two handsets)	You are calling all other handsets.
Calling HANDSET X (for models with more than two handsets) Calling other handset (for models with two handsets)	You are calling another handset.
Call transferred	You have successfully transferred an outside call to another handset.
Calls will be answered	You have changed an answering system setting while the answering system is off. The answering system turns on automatically to answer calls.
Calls will not be answered. Memory full	You have changed an answering system setting while the answering system is off. The answering system turns on automatically but it will not answer calls due to lack of memory space.
Cell	The cell line is in use.
Cell call on hold	A call on the cell line has been put on hold.
Cell line in use	Another system handset is using the cell line.
Cellular phone not connected	There is no cell phone connected when you try to make a call on the cell line.

Appendix

Display screen messages (continued)

Connecting...	Connection is establishing between the telephone base and the Bluetooth device.
Connection failed	Unsuccessful connection between a Bluetooth device and the telephone base.
Connecting to all handsets...	You are trying to start a PTT session to all other handsets.
Cell Phone A is added and connected to base.	The Bluetooth device is successfully added and connected to the telephone base.
Device list is empty	There are no Bluetooth devices paired to the telephone base.
Device disconnected	A Bluetooth device is disconnected.
Device renamed	A Bluetooth device is renamed.
Directory empty	There are no directory entries.
Directory full	The directory is full.
Download fail	The telephone system failed to download the directory from a cell phone.
Downloading dir	The telephone system is downloading the directory from a cell phone.
Ended	You have just ended a call.
End of messages	You have listened to all messages in the answering system.
Handset X is calling (for models with more than two handsets) Other handset is calling (for models with two handsets)	Another system handset is calling.
Handset X is calling all	One of the system handset is calling all others.
Headset X is deactivated	The headset is deactivated from the active slot.
Headset not connected!	The Bluetooth headset is not connected to the telephone base.
Home	The home line is in use.
Home call on hold	A call on the home line has been put on hold.
Home & cell calls on hold	Calls on the home and cell lines have been put on hold.
Home & cell lines in use	Calls on the home and cell lines are in use while all other handsets are in idle mode.

Appendix

Display screen messages (continued)

Home line in use	Another system handset or another telephone on the same home line is in use.
Home Transfer from HANDSET X (for models with more than two handsets) Home Transfer from other handset (for models with two handsets)	One handset is receiving an outside call transferred from another handset.
Home Transfer from HANDSET X to all	All handsets are receiving an outside call transferred from another handset.
Home Transfer from other handset	All handsets are receiving an outside call transferred from another handset.
Incoming call	There is an incoming call.
Incorrect PIN	The PIN number for adding a Bluetooth device is incorrect.
Intercom	The handset is on an intercom call.
Intercom ended	You have just ended an intercom call.
Key tone off	The key tone volume is set as off.
Less than 3 min to record	The answering system memory is low.
Low battery	The battery needs to be recharged.
Message deleted	The message is deleted.
Memory full	The memory for recording messages and memos is full.
Microphone on	The mute feature is turned off and the person on the other end can hear you.
Microphone off	You have turned off the handset microphone. The other party cannot hear you but you can hear the other party.
New voicemail	There are new voicemail messages from your telephone service provider for the home line.
No answer. Try again.	You tried to make an intercom call, but the handset you are calling is busy or out of range.
No cellular is ready for connection.	There are no cell phones in an active slot to connect with the telephone base.
No Incoming PTT	The incoming PTT function is disabled. The handset will not receive PTT calls.

Appendix

Display screen messages (continued)

No entries found. Try downloading from SIM only	There are no entries found when you download a cell phone directory from the cell memory.
No entries found. Try downloading from Phone only	There are no entries found when you download a cell phone directory from your SIM card. There are no entries found in either the cell or SIM card when you download a cell phone directory from both memories.
No headset found	No Bluetooth headset can be found.
No home line	There is no telephone line connected.
No signal. Call ended.	Communication between the handset and telephone base is lost during a call.
Not available at this time	One handset is already viewing the caller ID log, directory or answering system, and another handset attempts to review it. One handset attempts to place a PTT call to another handset which is on an outside or intercom call, or accessing the answering system.
Out of range OR No power at base	The handset has lost communication with the telephone base. There is no power connected to the telephone base.
Only 1 headset in device list can be ready for connection.	One headset is already connected to the telephone base.
Only 2 devices can be ready for connection	There are already two Bluetooth devices active or connected.
Only for 7 digits dialing from Caller ID log	The area code will be removed from caller ID entries to allow seven digit local dialing.
** Paging **	The system handset is being paged.
Place in charger	The battery is very low. The handset should be placed in the telephone base or charger to recharge.
Please use cell to connect to base.	You need to use your cell phone to establish a connection to the telephone base.
Please use headset to connect to base.	You need to use your headset to establish a connection to the telephone base.

Appendix



Display screen messages (continued)

PTT From HANDSET X To HANDSET Y	One handset has started a PTT session to another handset.
PTT To HANDSET X	You have started the PTT process.
Push to talk Ended	The PTT session is ended.
Put handset on BASE to re-register	Your handset is not registered to the telephone base.
Rec mem full	The answering system has no recording time left.
Rec mem low	The answering system has less than 3 minutes to record.
Redial empty	There are no entries in the redial list.
Registration failed	You failed to register a handset to the telephone base.
Ringer muted	The ringer is muted temporarily during an incoming call or intercom call.
Saved	Your selection has been saved.
Transferring call to HANDSET X Transferring call to all (for models with more than two handsets) Transferring to other handset (for models with two handsets)	One handset is transferring an outside call to another handset.
Unable to save	You tried to save a caller ID entry with no caller ID information.
XX Missed calls	There are missed calls that have not been reviewed in your caller ID log.
XX New messages	There are new messages recorded in the answering system.

Appendix

Handset and telephone base indicators

Handset lights















	On when the handset speakerphone is in use.
 /CELL	Flashes quickly when there is an incoming cell call. Flashes slowly when the cell line is on hold.
 /HOME/FLASH	Flashes quickly when there is an incoming home call. Flashes slowly when the home line is on hold.
CHARGE	On when the handset is charging in the telephone base or charger.

Telephone base lights

 /ANS ON/OFF	On when the answering system is turned on.
D1/D2	On when a Bluetooth device is connected to the base. Flashes alternately while pairing a Bluetooth device. Flashes quickly when there is an incoming cell call.
IN USE	On when the telephone line is in use or on hold. On when the answering system is answering a call. On when you are registering a handset. Flashes quickly when there is an incoming call. Flashes when another telephone sharing the same line is in use.

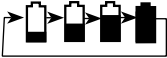
Appendix

Handset icons

	HOME line - on steadily when the home line is in use or there is an incoming home call.
 	CELL line - on steadily when the cell line is in use or there is an incoming cell call.
	Bluetooth connected devices - indicates that there are Bluetooth connected devices on the device list.
	Bluetooth disconnected devices - indicates that there are Bluetooth disconnected devices on the device list.
 	Wireless Bluetooth headset - on steadily when a wireless Bluetooth headset is in use on the home line.
	Speakerphone - the speakerphone is in use.
	Ringer off - on steadily when all the ringers of Home , Cellular 1 and Cellular 2 are turned off. Flashes when only one or two of the ringers are turned off.
	New voicemail - indicates you have new voicemail messages from the telephone service provider for the home line.
	New answering system message - indicates you have new answering system messages.
	Battery status - animates when the battery is charging. Becomes solid when the battery is fully charged.
	Battery status - flashes when the battery is low and needs charging.
	Answering system on - indicates that the answering system is turned on to answer incoming home calls.
	New caller ID log - indicates that the missed call is new.
	Mute - the microphone is muted.

Appendix

Headset indicators

Headset alert tones

One beep	Headset key tone.
One beep every 30 seconds	Muted headset microphone alert tone.
Two quick beeps	Error alert tone. The volume reaches its minimum or maximum setting.
Two rapid beeps every 20 seconds	Low battery warning.
Three rapid beeps	The headset is being powered on or off.
Three rapid beeps every 20 seconds	Out of range while the headset is on a call. A non-registered headset with a charged battery.
Ringer tone	Incoming call alert tone.

Headset lights

Red	On when the headset is charging in the telephone base. Flashes once every 10 seconds to indicate the battery is low. Flashes three times when the headset is being powered off.
Blue	On when the headset is fully charged in the telephone base. Flashes once every 10 seconds when the charged headset is in idle mode. Flashes twice every three seconds when the headset is in use. Flashes three times when the headset is being powered on. Flashes four times every four seconds when there is an incoming call. Flashes quickly in blue while being paged.
Red and blue	Flashes quickly and alternately when the headset is trying to register to a telephone base. Flashes slowly and alternately when the headset is not registered.
Off	The headset battery is depleted. The headset has been powered off.

Appendix

Expand your telephone system

The handsets provided with your telephone system are already registered. Additional handsets registered to the telephone system are assigned in sequential order. For instance, if you already have **HANDSET 1** and **HANDSET 2**, the new registered handset is assigned **HANDSET 3**. This telephone system accommodates up to 12 handsets.

Add and register a handset

You can add new handsets (**DS6401**, purchased separately) to your telephone system, but each handset must be registered with the telephone base before use. When first purchased, each expansion handset shows **Put handset on BASE to register** after a battery is installed. You may need to charge the handset before registering it to the telephone base. For more details on battery charging, see the table on page 5.

To register a handset:

1. Make sure the handset is out of the telephone base or handset charger and shows **Put handset on BASE to register**. Place the handset you wish to register in the telephone base.
2. The handset displays **Registering handset...** and the red **IN USE** light on the telephone base turns on. It takes about 90 seconds to complete the registration process. The handset displays **HANDSET X Registered** (**X** represents the registered handset number). The **IN USE** light on the telephone base turns off and you hear a confirmation tone from the handset when registration completes.

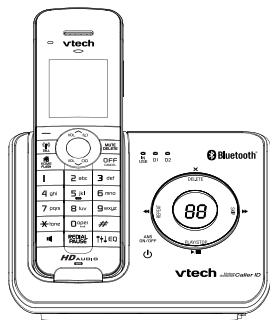

If registration fails, the system will automatically try to register again. If registration fails after the third try, the handset displays **Registration failed** then **Put handset on BASE to register** and the telephone base beeps. This may take up to five minutes to occur.

To reset the handset, remove it from the telephone base. When the handset displays **Put handset on BASE to register**, try the registration process again.

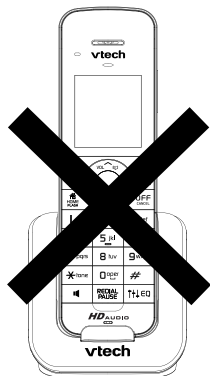

note



You cannot register a handset if any other system handset is in use.



Appendix

Add and register a headset

This telephone system accommodates up to two cordless headsets. You can buy an additional cordless headset (**IS6100**, purchased separately) for the telephone base. You can register a maximum of two headsets to the telephone base. The telephone base recognizes and counts a headset the same as a handset. The headset must be registered with the telephone base before use. You may need to charge the headset before registering it to the telephone base. For more details on battery charging, see page 6.

To register a headset:

1. Place the non-registered headset in the headset charger and allow it to charge for at least 15 minutes before beginning registration. Remove the headset from the headset charger. The  light on the headset flashes slowly and alternately in red and blue.
2. On the telephone base, press and hold  **FIND HANDSET** for about four seconds until the red **IN USE** light turns on.
3. Immediately place the headset in the headset charger. It takes about 60 seconds to complete the registration. The red **IN USE** light on the telephone base turns off. The  light on the headset turns red when it is registered but not fully charged, or turns blue if it is registered and fully charged.

If the registration process is successful, you hear a dial tone when you press  on the headset. If the registration fails, you hear “*Not registered*” through the headset earpiece when you press  on the headset. The  light on the headset flashes slowly and alternately in red and blue. To reset the headset, remove it from the headset charger and then place it back into its charger. Try the registration process again.

note

- You cannot register a headset if any other system handset or headset is in use.
- The headset must be deregistered before registering it to another telephone system.

Appendix

Deregister handsets/headsets

If you want to replace a handset or headset, or reassign the designated handset number of a registered handset, you must deregister all handsets and headsets that are registered to the telephone base. Then register each handset and/or headset you wish to use individually.

To make deregistration easier, read all of the instructions on this page before you begin.

To deregister all handsets:

1. Make sure that all handsets are out of the telephone base and handset chargers before you begin deregistration.
2. Press and hold **FIND HANDSET** on the telephone base for about 10 seconds until the **IN USE** light flashes.
3. Quickly press **FIND HANDSET** again. You must press **FIND HANDSET** while the **IN USE** light is still flashing. The **IN USE** light flashes for about five seconds. If the light stops flashing, start again with Step 1 above.
4. All system handsets show **Put handset on BASE to register** and all headset **⓪** lights flash slowly and alternately in red and blue. You hear a confirmation tone when deregistration completes. The deregistration process takes about 10 seconds to complete.

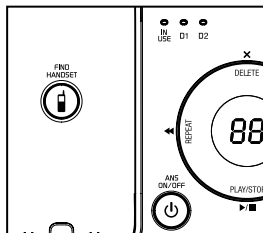

If the deregistration process is successful, you hear “*Not registered*” through the headset earpiece when you press **⓪** on the headset. If deregistration fails, you may need to reset the telephone and try again.

To reset:

1. Press and hold **OFF/CANCEL** or place the handset back in the telephone base.
2. Pick up the registered headset and press the **RESET** inset button with a paper clip or similar object.

- OR -

- Unplug the power from the telephone base, then plug it back in.

note

- You cannot deregister the handsets and headsets if any system handset or headset is in use.
- Even if the battery is depleted, you can still deregister the handsets by following the steps above.

Appendix

Troubleshooting

If you have difficulty with your telephone or headset, please try the suggestions below. For customer service, visit our website at www.vtechphones.com or call 1 (800) 595-9511. In Canada, go to www.vtechcanada.com or dial 1 (800) 267-7377.

I cannot add my cell phone to the telephone base.

- Make sure you have cellular coverage.
- Make sure your cell phone is compatible with your **DS6472**. Check the Bluetooth compatibility list at www.vtechphones.com.
- Make sure the Bluetooth function of your cell phone is turned on. See the user's manual of your cell phone for more information.
- Remove **VTech DS6472** from your cell phone's handsfree device history list (see the user's manual of your cell phone for more information).
- Carefully follow the pairing instructions on page 25 and make sure that your cell phone is not connected to any other Bluetooth device.
- Turn off your cell phone, then turn it on again.
- Reset the telephone base. Unplug the unit's electrical power. Wait for approximately 15 seconds, then plug it back in. Repeat the above suggestions.

I cannot add my Bluetooth headset to the telephone base.

- Make sure that your Bluetooth headset is in discoverable mode when pairing with the telephone base. See the user's manual of your headset for more information on how to set your headset to discoverable mode.
- Carefully follow the pairing instructions on page 27 and make sure that your headset is not connected to any other Bluetooth device.
- Reset the telephone base. Unplug the unit's electrical power. Wait for approximately 15 seconds, then plug it back in. Repeat the above suggestions.

I cannot connect my cell phone with the telephone base.

- Make sure that the Bluetooth function of your cell phone is turned on. See the user's manual of your cell phone for more information.
- Make sure that your Bluetooth cell phone is not connected to any other Bluetooth device.
- Turn off your cell phone, then turn it on again.
- Make sure that your cell phone is connected and active on the device list.
- For some cell phones, you must authorize **VTech DS6472** device in your cell phone's Bluetooth feature. See the user's manual of your cell phone for more information.
- Manually connect your cell phone to **VTech DS6472**. Refer to the user's manual of your cell phone for more information.

I cannot connect my Bluetooth headset with the telephone base.

- Make sure that your Bluetooth headset is not connected to any other Bluetooth device.
- Make sure that your Bluetooth headset is connected and active on the device list.

Appendix

Troubleshooting

I cannot put my Bluetooth headset in discoverable mode.

- Refer to the user's manual of your Bluetooth headset for information on how to set your headset to discoverable mode.
- Make sure that the Bluetooth headset is not connected to any other Bluetooth device in order to successfully pair and connect to the telephone base.
- Carefully follow the pairing process on page 27.
- Reset the telephone base. Unplug the unit's electrical power. Wait for approximately 15 seconds, then plug it back in. Repeat the above suggestions.

I cannot find VTech DS6472 on my cell phone.

- Make sure that the telephone base is in discoverable mode. Carefully follow the setup instructions on page 25.
- Make sure that you manually set your cell phone to search for devices.
- Remove **VTech DS6472** from your cell phone's handsfree device history list (see the user's manual of your cell phone).
- Turn off your cell phone, then turn it on again.
- Reset the telephone base. Unplug the unit's electrical power. Wait for approximately 15 seconds, then plug it back in. Repeat the above suggestions.

I don't know how to search for or add new devices on my cell phone.

- Most cell phones have the Bluetooth feature in the connection or setup menus. Please refer to the user's manual of your cell phone.
- In general, press the menu key on your cell phone, then look for the Bluetooth menu in the settings or connection menu. In the Bluetooth menu, select the option to search for or add new devices.

My cell phone disconnects with the telephone base.

- Turn off your cell phone, then turn it on again.
- Make sure that you are not using your cell phone when on a cell call.

My cell phone is connected to the telephone base, but I cannot make a cell call.

- Make sure that your cell phone is not in use when you are trying to make a cell call.
- For some smartphones, make sure that the cellular function is turned on.

Bluetooth system busy appears on the display.

- Make sure that your cell phone is not in use when connected and active on the device list.
- Make sure that your Bluetooth cell phone or headset is not connected to any other Bluetooth device.
- **DS6472** can only use one Bluetooth device at a time.

Appendix

Troubleshooting

The PIN on the telephone base does not work.

- The default PIN is **0000**.
- If you have changed the PIN, it will appear on the handset in the pairing process.

I cannot hear any audio on my telephone system when on a cell call.

- Reset the telephone base. Unplug the unit's electrical power. Wait for approximately 15 seconds, then plug it back in.
- Turn off your cell phone, then turn it on again.

I cannot download contacts from my cell phone to the DS6472.

- Make sure that your cell phone is paired and connected to the base.
- Make sure you place your cell phone next to the base while downloading.
- If your cell phone does not support the download, you can send the directory from your cell phone. The system can receive the directory automatically.

I see duplicate entries in my downloaded directory

- If you see duplicate directory entries, you can delete them manually. Another option is to download again either your SIM card or phone memory, but not both.

Some of my cell phone contacts were not imported to the DS6472.

- Make sure to try transferring the contacts from your SIM card to your phone memory first, then download from your phone memory. If that doesn't work, try transferring the contacts from your phone memory to your SIM card, then download from your SIM card. For more information on how to transfer contacts between your SIM card and your phone memory, refer to the user's manual of your cell phone.

Can the DS6472 help the poor cell phone reception in my house?

- If your cell phone has poor reception in your home, the **DS6472** cannot improve the reception. However, if there is a location in your house with better reception, you can leave your cell phone at that location while you use **DS6472** cell line. In order for this to work, the telephone base must be within 30 feet of the cell phone.

The listening volume of my cell call is too loud or quiet.

- During a cell call, if the listening volume is too loud or quiet, try changing the volume on your cell phone. On some cell phones, changing the volume on the cell phone affects your cell call volume on the **DS6472** handset.

Appendix

Troubleshooting

My telephone does not work at all.

- Make sure the battery is installed and charged correctly (page 4). For optimum daily performance, return the handset to the telephone base or charger after use.
- Make sure the power adapter is securely plugged into an outlet not controlled by a wall switch.
- Make sure the telephone line cord is plugged firmly into the telephone base and the telephone wall jack.
- Unplug the electrical power to the telephone base. Wait for approximately 15 seconds, then plug it back in. Allow up to one minute for the cordless handset and telephone base to synchronize.
- Charge the battery in the handset for up to 16 hours.
- If the battery is completely depleted, charge it for at least 30 minutes before use (page 5).
- Remove and install the battery again. If that still does not work, it may be necessary to purchase a new battery.
- Disconnect the telephone base from the telephone wall jack and plug in a working telephone. If the other telephone does not work, the problem is probably in the wiring or telephone service. Call the telephone service provider.

Low battery shows on screen.

- Place the handset in the telephone base or charger for recharging.
- Remove and install the battery again and use it until fully depleted, then recharge the handset in the telephone base or charger for up to 16 hours.
- If the above measures do not correct the problem, replace the battery.

The battery does not charge in the handset or the handset battery does not accept charge.

- Make sure the handset is placed in the telephone base or charger correctly. The **CHARGE** light on the handset should be on.
- Remove and install the battery again, then charge for up to 16 hours.
- If the handset is in the telephone base or charger but the **CHARGE** light on the handset is not on, refer to **The CHARGE light is off** below.
- If the battery is completely depleted, charge it for at least 30 minutes before use (page 5).
- Purchase a new battery.

The CHARGE light is off.

- Clean the charging contacts on the handset, telephone base and charger each month with a pencil eraser or a dry non-abrasive fabric.
- Make sure the power adapter and telephone line cord are plugged in correctly and securely.
- Unplug the power adapter. Wait for 15 seconds before plugging it back in. Allow up to one minute for the handset and telephone base to reset.

Appendix

Troubleshooting

The display shows No line. I cannot hear the dial tone.

- Disconnect the telephone line cord from your telephone and connect it to another telephone. If there is no dial tone on that other telephone either, then the telephone line cord may be defective. Try installing a new telephone line cord.
- If changing telephone line cord does not help, the wall jack (or the wiring to this wall jack) may be defective. Contact your telephone service provider.
- You may be using a new cable or VoIP service, the existing telephone jacks in your home may no longer work. Contact your service provider for solutions.

The telephone does not ring when there is an incoming call.

- Make sure the handset ringer volume is not set to off (page 37) and the telephone base ringer volume is not set to off (page 49).
- Make sure the telephone line cord and power adapter are plugged in properly (page 3).
- The handset may be too far from the telephone base. Move it closer to the telephone base.
- There may be too many extension phones on the telephone line to allow all of them to ring simultaneously. Unplug some of them.
- If other telephones in your home are having the same problem, the problem is in the wiring or telephone service. Contact your telephone service provider (charges may apply).
- Other electronic products such as HAM radios and other DECT phones can cause interference with your cordless phone. Try installing your phone as far away as possible from these types of electronic devices.
- Test a working telephone at the telephone wall jack. If another telephone has the same problem, the problem is in the telephone wall jack. Contact your telephone service provider (charges may apply).
- The telephone line cord may be defective. Install a new telephone line cord.
- Remove and install the battery again and then place the handset in the telephone base or charger.
- Wait for the handset to synchronize with the telephone base. Allow up to one minute for this to take place.

I cannot dial out.

- Try all the above suggestions.
- Make sure there is a dial tone before dialing. It is normal if the handset takes a second or two to synchronize with the telephone before producing a dial tone. Wait an extra second before dialing.
- If other telephones in your home are having the same problem, the problem is in the wiring or telephone service. Contact your telephone service provider (charges may apply).
- Eliminate any background noise. Mute the cordless handset before dialing, or dial from another room in your home with less background noise.

Appendix

Troubleshooting

My handset beeps and is not performing normally.

- Make sure the power cord is securely plugged into the telephone base. Plug the telephone base into a different working electrical outlet not controlled by a wall switch.
- Move the handset closer to the telephone base. It may be out of range.
- Reset the telephone base by unplugging the electrical power to the base. Wait for 15 seconds and plug it back in again. Allow up to one minute for the cordless handset and the telephone base to synchronize.
- Other electronic products such as HAM radios and other DECT phones can cause interference with your cordless phone. Try installing your phone as far away as possible from these types of electronic devices.

There is interference during a telephone conversation.

My calls fade out when I am using the cordless handset/headset.

- The handset or headset may be out of range. Move it closer to the telephone base.
- If you subscribe to high-speed Internet service (DSL - digital subscriber line) through your telephone line, you must install a DSL filter between the telephone line cord and the telephone wall jack. The filter prevents noise and caller ID problems caused by DSL interference. Please contact your DSL service provider for more information about DSL filters.
- Appliances or other cordless telephones plugged into the same circuit as the telephone base can cause interference. Try moving the appliance or telephone base to another outlet.
- Other electronic products such as HAM radios and other DECT phones can cause interference with your cordless phone. Try installing your phone as far away as possible from these types of electronic devices.
- If your telephone is plugged in with a modem or a surge protector, plug the telephone (or modem/surge protector) into a different location. If this doesn't solve the problem, relocate your telephone or modem farther apart from each other, or use a different surge protector.
- The location of your telephone base can impact the performance of your cordless phone or headset. For better reception, install the telephone base in a centralized location within your home or office, away from walls or other obstructions. In many environments, elevating the telephone base improves overall performance.
- Disconnect the telephone base from the telephone wall jack and plug in a corded telephone. If calls are still not clear, the problem is probably in the wiring or telephone service. Contact your telephone service provider (charges may apply).
- If other telephones in your home are having the same problem, the problem is in the wiring or telephone service. Contact your telephone service provider (charges may apply).

I hear other calls when using the cordless handset/headset.

- Disconnect the telephone base from the telephone wall jack. Plug in a different telephone. If you still hear other calls, the problem is probably in the wiring or telephone service. Call your telephone service provider.

Appendix

Troubleshooting

I hear noise on the cordless handset and the keys do not work.

- Make sure the telephone line cord is plugged in securely.

Registration failed appears on the handset.

- Only one handset can be registered at a time. If you have multiple handsets to register, please follow the instructions on page 104 for the first handset. Once a handset has been successfully registered, repeat the steps for each handset that needs to be registered.
- Make sure that the telephone base, handsets and headsets are in idle mode when registering a handset.
- Follow the steps on page 119 for the common cure for electronic equipment, then try again to register a handset.
- If you have already registered the maximum numbers of handsets and/or headsets, you need to follow the deregistration instructions before registering a handset. Refer to **Expand your telephone system** on page 104 and **Deregister handsets/headsets** on page 106.

My headset does not work at all.

- Make sure the telephone line cord is plugged firmly into the telephone base and the telephone wall jack.
- Charge the headset in the headset charger for up to three hours.
- Unplug the electrical power to the telephone base. Wait for approximately 15 seconds, then plug it back in. Allow up to one minute for the cordless headset and telephone base to synchronize.
- Other electronic products such as HAM radios and other DECT phones can cause interference with your cordless phone. Try installing your phone as far away as possible from these types of electronic devices.
- If the headset battery is completely depleted, it may take up to 15 minutes to charge the headset before the headset has enough charge to use for a short time.
- The headset battery may be defective. Contact our customer service for assistance.

I cannot dial out from my cordless headset.

- You must use a telephone on the same line to dial out. Once you have dialed the number, you can press **Ⓟ** on the headset to take the call. After the headset is activated, you can hang up the handset from which you dialed from.
- If other telephones in your home are having the same problem, the problem is in your wiring or telephone service. Contact your telephone service provider (charges may apply).



The blue or red light keeps flashing on the headset **Ⓟ key.**

- Different flashing patterns of the red and/or blue lights indicate different conditions of the headset. See **Headset indicators** on page 103.

Appendix

Troubleshooting

The headset does not charge in the headset charger.

- Make sure the headset charger adapter is securely plugged into an electrical outlet (page 3). For optimum daily performance, return the headset to the headset charger after use.
- Make sure the cordless headset is placed in the headset charger correctly. The headset  light should be on.
- Unplug the power adapter and then plug it back, then charge for up to three hours.
- If the cordless headset is in the headset charger and the headset light is not on, refer to **The  light on the headset is off while charging** below.
- If the battery is completely depleted, it may take up to 15 minutes to charge the headset before it has enough charge to be used for a short time. For optimum daily performance, return the cordless headset to the headset charger when not in use.
- The headset battery may be defective. Contact our customer service for assistance.

The light on the headset is off while charging.

- Make sure the power adapter is correctly and securely plugged in the electrical outlet.
- Make sure the headset is sitting properly in the headset charger to charge.
- Clean the charging contacts on the headset and headset charger each month with a pencil eraser or a dry non-abrasive fabric.
- Unplug the power adapter. Wait for 15 seconds before plugging it back in.

My cordless headset is not performing normally.

- Make sure the power cord is correctly and securely plugged into the telephone base. Plug the telephone base into a different working electrical outlet not controlled by a wall switch.
- Move the cordless headset closer to the telephone base. It may be out of range.
- Other electronic products such as HAM radios and other DECT phones can cause interference with your cordless phone. Try installing your phone as far away as possible from these types of electronic devices.
- If you have tried the above suggestions and the headset is still not performing normally, press the **RESET** inset button with a paper clip or similar object once to restart the headset.

Appendix

Troubleshooting

I cannot hear any ring tone from the cordless headset when there is an incoming call.

- The headset does not have an external ringer. The ring tone can only be heard through the headset earpiece.
- Make sure the headset ringer volume is not set to the lowest level (page 37).
- If you have pressed **MUTE/FLASH** on the cordless headset when it is ringing, it mutes the ring tone of the headset. The ring tone resumes on the next call.
- The headset may be too far from the telephone base. Move it closer to the telephone base.
- You may have too many extension phones on the telephone line to allow all of them to ring simultaneously. Unplug some of them.
- The layout of your home or office may be limiting the operating range. Try moving the telephone base to another location, preferably on a higher location.
- If other telephones in your home are having the same problem, the problem is in the wiring or telephone service. Contact your telephone service provider.
- Other electronic products such as HAM radios and other DECT phones can cause interference with your cordless phone. Try installing your phone as far away as possible from these types of electronic devices.
- Test a working telephone at the telephone wall jack. If another telephone has the same problem, there may be problem with the telephone wall jack. Contact your telephone service provider.
- The telephone line cord may be defective. Install a new telephone line cord.

I cannot register a cordless headset.

- Only two headsets can be registered to this telephone system (page 105).
- If you have already registered the maximum numbers of handsets and/or headsets, you need to follow the deregistration instructions before registering a headset. Refer to **Expand your telephone system** on page 104 and **Deregister handsets/headsets** on page 106.
- Make sure that all registered handsets, headsets and the telephone base are in idle mode when registering a headset.
- Follow the steps in **Common cure for electronic equipment** (page 119), then try again to register a headset.

Appendix

Troubleshooting

My caller ID features are not working properly.

- Caller ID is a subscription service. You must subscribe to this service from your telephone service provider for this feature to work on your telephone.
- The caller may not be calling from an area which supports caller ID.
- Both your and the caller's telephone service providers must use equipment compatible with the caller ID service.
- The caller ID information shows after the first or second ring.
- If you subscribe to high-speed Internet service (DSL - digital subscriber line) through your telephone line, you must install a DSL filter between the telephone line cord and the telephone wall jack. The filter prevents noise and caller ID problems caused by DSL interference. Contact your DSL service provider for more information about DSL filters.

The telephone does not receive caller ID or the telephone does not show caller ID during call waiting.

- Make sure you subscribe to caller ID with call waiting features provided by your telephone service provider.
- The caller may not be calling from an area which supports caller ID.
- Both your and the caller's telephone service providers must use equipment compatible with caller ID service.
- If you subscribe to high-speed Internet service (DSL - digital subscriber line) through your telephone line, you must install a DSL filter between the telephone line cord and the telephone wall jack. The filter prevents noise and caller ID problems caused by DSL interference. Contact your DSL service provider for more information about DSL filters.

Caller ID entries do not match the numbers I need to dial.

- Caller ID service delivers 10 digits (the area code plus the seven-digits number). If you need to dial something other 10 digits, see page 79 for instructions on changing the number.
- If you dial seven digits for local calls, you may want to use the home area code feature (page 47).

Out of range OR No power at base shows on the handset.

- The handset may be out of range. Move it closer to the telephone base.
- Make sure the power cord is securely plugged into the telephone base. Use a working electrical outlet not controlled by a wall switch.
- Reset your telephone by unplugging the power adapter from the telephone base. Disconnect the battery from the cordless handset. Wait for 15 seconds, then plug in the power adapter and reinstall the battery. Place the handset in the telephone base and allow up to one minute for the handset and telephone base to synchronize.
- Other electronic products such as HAM radios and other DECT phones can cause interference with your cordless phone. Try installing your phone as far away as possible from these types of electronic devices.

Appendix

Troubleshooting

and New voicemail appear on the handsets and I don't know why.

- Your telephone has voicemail indication that is separate from the built-in answering system. If  and **New voicemail** appear on the handsets, your telephone has received a signal from your telephone service provider that you have a voicemail message waiting for you to retrieve from your telephone service provider. Contact your telephone service provider for more information on how to access your voicemail.

I cannot retrieve my voicemail messages.

- Your telephone has both a built-in answering system and voicemail indication. They are independent features and each alerts you to new messages differently (page 89). If you subscribe to voicemail service from your telephone service provider, contact your telephone service provider for more information on how to access your voicemail.



The answering system does not answer after the correct number of rings.

- Make sure the answering system is on. When the answering system is on, **ANS ON** should be shown on the handset and /ANS ON/OFF light on the telephone base should be on.
- If toll saver is selected, the number of rings changes to two when there are new messages waiting (page 86).
- If the memory is full or if the answering system is off, the answering system answers after 10 rings.
- In some cases, the answering system is affected by the ringing system used by the telephone service provider.
- If you subscribe to voicemail service, change the number of rings so that your answering system answers before your voicemail answers (page 86). To determine how many rings activate your voicemail, contact your telephone service provider.
- If there is a fax machine connected to the same telephone line, try disconnecting the fax machine. If that solves the problem, consult your fax machine documentation for information on compatibility with answering systems.

The outgoing announcement is not clear.

- When recording the announcement, make sure you speak in a normal tone of voice towards the microphone of the handset.
- Make sure there is no background noise when recording.

The messages on the answering system are very difficult to hear.

- Press /VOL on the side of telephone base or **VOL**/ on the handset to increase the speaker volume.

Appendix

Troubleshooting

The answering system does not record messages.

- Make sure the answering system is on.
- When the answering machine memory is full, it does not record new messages until some old messages are deleted.
- If you subscribe to voicemail service, change the number of rings so that your answering system answers before your voicemail answers (page 86). To determine how many rings activate your voicemail, contact your telephone service provider.
- If there is a fax machine connected to the same telephone line, try disconnecting the fax machine. If that solves the problem, consult your fax machine documentation for information on compatibility with answering systems.

The messages on the answering system are incomplete.

- If a caller leaves a very long message, part of it may be lost when the answering system disconnects the call after three minutes or the recording time set.
- If the memory on the answering system becomes full during a message, the answering system stops recording and disconnects the call.
- If the caller's voice is very soft, the answering system may stop recording and disconnect the call.

The answering system does not respond to remote commands.

- Make sure your remote access code is correct (page 87).
- Make sure you are calling from a touch-tone telephone. When dialing a number, there should be tones. If there are clicks, then it is not a touch-tone telephone and cannot activate the answering system.
- The answering system may not detect the remote access code when your announcement is playing. Wait until the announcement is over before entering the code.
- There may be interference on the telephone line you are using. Press the dialing keys firmly when dialing.

I subscribe to a nontraditional telephone service that uses my computer to establish connections, and my telephone doesn't work.

- Make sure your computer is powered on.
- Make sure your Internet connection is working properly.
- Make sure that the software is installed and running for your nontraditional telephone service.
- Make sure to plug your USB telephone adapter into a dedicated USB port on your computer. Do not plug into a multiple port USB hub (USB splitter) that is not powered.
- In a few rare instances, the USB port on your computer may not have enough power. In these instances, try using a USB hub with its own external power supply.
- If you are using a firewall, it may prevent access to your nontraditional telephone service. Contact your service provider for more information.

Appendix

Troubleshooting

Common cure for electronic equipment.

- If the telephone is not responding normally, put the cordless handset in the telephone base. If it does not fix the problem, try the following (in the order listed):
 1. Disconnect the power to the telephone base.
 2. Disconnect the battery on the cordless handset.
 3. Wait a few minutes before connecting power to the telephone base.
 4. Install the battery again and place the cordless handset in the telephone base.
 5. Wait for the cordless handset to synchronize with the telephone base. Allow up to one minute for this to take place.

Appendix

Important safety instructions

When using your telephone equipment, basic safety precautions should always be followed to reduce the risk of fire, electric shock and injury, including the following:

1. Read and understand all instructions.
2. Follow all warnings and instructions marked on the product.
3. Unplug this product from the wall outlet before cleaning. Do not use liquid or aerosol cleaners. Use a dry non-abrasive cloth for cleaning.
4. Do not use this product near water such as near a bath tub, wash bowl, kitchen sink, laundry tub or swimming pool, or in a wet basement or shower.
5. Do not place this product on an unstable table, shelf, stand or other unstable surfaces.
6. Slots and openings in the back or bottom of the telephone base and handset are provided for ventilation. To protect them from overheating, these openings must not be blocked by placing the product on a soft surface such as a bed, sofa or rug. This product should never be placed near or over a radiator or heat register. This product should not be placed in any area where proper ventilation is not provided.
7. This product should be operated only from the type of power source indicated on the marking label. If you are not sure of the type of power supply in your home or office, consult your dealer or local power company.
8. Do not allow anything to rest on the power cord. Do not install this product where the cord may be walked on.
9. Never push objects of any kind into this product through the slots in the telephone base or handset because they may touch dangerous voltage points or create a short circuit. Never spill liquid of any kind on the product.
10. To reduce the risk of electric shock, do not disassemble this product, but take it to an authorized service facility. Opening or removing parts of the telephone base or handset other than specified access doors may expose you to dangerous voltages or other risks. Incorrect reassembling can cause electric shock when the product is subsequently used.
11. Do not overload wall outlets and extension cords.
12. Unplug this product from the wall outlet and refer servicing to an authorized service facility under the following conditions:
 - A. When the power supply cord or plug is damaged or frayed.
 - B. If liquid has been spilled onto the product.
 - C. If the product has been exposed to rain or water.
 - D. If the product does not operate normally by following the operating instructions. Adjust only those controls that are covered by the operation instructions. Improper adjustment of other controls may result in damage and often requires extensive work by an authorized technician to restore the product to normal operation.
 - E. If the product has been dropped and the telephone base and/or handset has been damaged.
 - F. If the product exhibits a distinct change in performance.
13. Avoid using a telephone (other than cordless) during an electrical storm. There is a remote risk of electric shock from lightning.
14. Do not use the telephone to report a gas leak in the vicinity of the leak. Under certain circumstances, a spark may be created when the adapter is plugged into the power outlet, or when the handset is replaced in its cradle. This is a common event associated with the closing of any electrical circuit. The user should not plug the phone into a power outlet, and should not put a charged handset into the cradle, if the phone is located in an environment containing concentrations of flammable or flame-supporting gases, unless there is adequate ventilation. A spark in such an environment could create a fire or explosion. Such environments might include: medical use of oxygen without adequate ventilation; industrial gases (cleaning solvents; gasoline vapors; etc.); a leak of natural gas; etc.
15. Only put the handset of your telephone next to your ear when it is in normal talk mode.
16. The power adapters are intended to be correctly oriented in a vertical or floor mount position. The prongs are not designed to hold the plug in place if it is plugged into a ceiling, under-the-table or cabinet outlet.

SAVE THESE INSTRUCTIONS

Appendix

Battery

- CAUTION: Use Only Supplied Battery.
- Do not dispose of the battery in a fire. Check with local waste management codes for special disposal instructions.
- Do not open or mutilate the battery. Released electrolyte is corrosive and may cause burns or injury to the eyes or skin. The electrolyte may be toxic if swallowed.
- Exercise care in handling batteries in order not to create a short circuit with conductive materials.
- Charge the battery provided with this product only in accordance with the instructions and limitations specified in this manual.

Precautions for users of implanted cardiac pacemakers

Cardiac pacemakers (applies only to digital cordless telephones):

Wireless Technology Research, LLC (WTR), an independent research entity, led a multidisciplinary evaluation of the interference between portable wireless telephones and implanted cardiac pacemakers. Supported by the U.S. Food and Drug Administration, WTR recommends to physicians that:

Pacemaker patients:

- Should keep wireless telephones at least six inches from the pacemaker.
- Should NOT place wireless telephones directly over the pacemaker, such as in a breast pocket, when it is turned ON.
- Should use the wireless telephone at the ear opposite the pacemaker.

WTR's evaluation did not identify any risk to bystanders with pacemakers from other persons using wireless telephones.

Operating range

This cordless telephone operates with the maximum power allowed by the Federal Communications Commission (FCC). Even so, this handset and telephone base can communicate over only a certain distance - which can vary with the locations of the telephone base and handset, the weather, and the layout of your home or office.

When the handset is out of range, the handset displays **Out of range OR No power at base**.

If there is a call while the handset is out of range, it might not ring, or if it does ring, the call might not connect well when you press **Ⓜ/HOME/FLASH**. Move closer to the telephone base, then press **Ⓜ/HOME/FLASH** to answer the call.

If the handset moves out of range during a telephone conversation, there might be interference.

To improve reception, move closer to the telephone base.

Maintenance

Taking care of your telephone

Your cordless telephone contains sophisticated electronic parts, so it must be treated with care.

Avoid rough treatment

Place the handset down gently. Save the original packing materials to protect your telephone if you ever need to ship it.

Avoid water

Your telephone can be damaged if it gets wet. Do not use the handset outdoors in the rain, or handle it with wet hands. Do not install the telephone base near a sink, bathtub or shower.

Electrical storms

Electrical storms can sometimes cause power surges harmful to electronic equipment. For your own safety, take caution when using electrical appliances during storms.

Cleaning your telephone

Your telephone has a durable plastic casing that should retain its luster for many years. Clean it only with a soft cloth slightly dampened with water or mild soap. Do not use excess water or cleaning solvents of any kind.

Appendix

Remember that electrical appliances can cause serious injury if used when you are wet or standing in the water. If the telephone base should fall into the water, **DO NOT RETRIEVE IT UNTIL YOU UNPLUG THE POWER CORD AND TELEPHONE LINE CORD FROM THE WALL.** Then remove the telephone by the unplugged cords.

About cordless telephones

- **Privacy:** The same features that make a cordless telephone convenient create some limitations. Telephone calls are transmitted between the telephone base and the cordless handset by radio waves, so there is a possibility that the cordless telephone conversations could be intercepted by radio receiving equipment within range of the cordless handset. For this reason, you should not think of cordless telephone conversations as being as private as those on corded telephones.
- **Electrical power:** The telephone base of this cordless telephone must be connected to a working electrical outlet. The electrical outlet should not be controlled by a wall switch. Calls cannot be made from the cordless handset if the telephone base is unplugged, switched off, or if the electrical power is interrupted.
- **Potential TV interference:** Some cordless telephones operate at frequencies that may cause interference to televisions and VCRs. To minimize or prevent such interference, do not place the telephone base of the cordless telephone near or on top of a TV or VCR. If interference is experienced, moving the cordless telephone farther away from the TV or VCR often reduces or eliminates the interference.
- **Rechargeable batteries:** Exercise care in handling batteries in order not to create a short circuit with conducting material such as rings, bracelets and keys. The battery or conductor may overheat and cause harm. Observe proper polarity between the battery and the battery charger.
- **Nickel-metal hydride rechargeable batteries:** Dispose of these batteries in a safe manner. Do not burn or puncture the battery. Like other batteries of this type, if burned or punctured, they could release caustic material which could cause injury.

The RBRC® seal



The RBRC® seal on the nickel-metal hydride battery indicates that VTech Communications, Inc. is voluntarily participating in an industry program to collect and recycle these batteries at the end of their useful lives, when taken out of service within the United States and Canada.

The RBRC® program provides a convenient alternative to placing used nickel-metal hydride batteries into the trash or municipal waste, which may be illegal in your area. VTech's participation in RBRC® makes it easy for you to drop off the spent battery at local retailers participating in the RBRC® program or at authorized VTech product service centers. Please call **1-800-8-BATTERY™** for information on Ni-MH battery recycling and disposal bans/restrictions in your area. VTech's involvement in this program is part of its commitment to protecting our environment and conserving natural resources.

RBRC® is a registered trademark of Rechargeable Battery Recycling Corporation.



The RBRC® seal on the lithium-ion battery indicates that VTech Communications, Inc. is voluntarily participating in an industry program to collect and recycle these batteries at the end of their useful lives, when taken out of service within the United States and Canada.

The RBRC® program provides a convenient alternative to placing used lithium-ion batteries into the trash or municipal waste, which may be illegal in your area. VTech's participation in RBRC® makes it easy for you to drop off the spent battery at local retailers participating in the RBRC® program or at authorized VTech product service centers. Please call **1 (800) 8 BATTERY™** for information on Li-ion battery recycling and disposal bans/restrictions in your area. VTech's involvement in this program is part of its commitment to protecting our environment and conserving natural resources.

RBRC® is a registered trademark of Rechargeable Battery Recycling Corporation.

Appendix

FCC, ACTA and IC regulations

FCC Part 15

This equipment has been tested and found to comply with the requirements for a Class B digital device under Part 15 of the Federal Communications Commission (FCC) rules. These requirements are intended to provide reasonable protection against harmful interference in a residential installation. This equipment generates, uses and can radiate radio frequency energy and, if not installed and used in accordance with the instructions, may cause harmful interference to radio communications. However, there is no guarantee that interference will not occur in a particular installation. If this equipment does cause harmful interference to radio or television reception, which can be determined by turning the equipment off and on, the user is encouraged to try to correct the interference by one or more of the following measures:

- Reorient or relocate the receiving antenna.
- Increase the separation between the equipment and receiver.
- Connect the equipment into an outlet on a circuit different from that to which the receiver is connected.
- Consult the dealer or an experienced radio/TV technician for help.

Changes or modifications to this equipment not expressly approved by the party responsible for compliance could void the user's authority to operate the equipment.

This device complies with Part 15 of the FCC rules. Operation is subject to the following two conditions: (1) this device may not cause harmful interference, and (2) this device must accept any interference received, including interference that may cause undesired operation. Privacy of communications may not be ensured when using this telephone.

To ensure safety of users, the FCC has established criteria for the amount of radio frequency energy that can be safely absorbed by a user or bystander according to the intended usage of the product. This product has been tested and found to comply with the FCC criteria. The handset may be safely held against the ear of the user. The telephone base shall be installed and used such that parts of the user's body other than the hands are maintained at a distance of approximately 20 cm (8 inches) or more.

This Class B digital apparatus complies with Canadian requirement:
CAN ICES-3 (B)/NMB-3(B)

FCC Part 68 and ACTA

This equipment complies with Part 68 of the FCC rules and with technical requirements adopted by the Administrative Council for Terminal Attachments (ACTA). The label on the back or bottom of this equipment contains, among other things, a product identifier in the format US: AAAEQ##TXXXX. This identifier must be provided to your telephone service provider upon request.

The plug and jack used to connect this equipment to premises wiring and the telephone network must comply with applicable Part 68 rules and technical requirements adopted by ACTA. A compliant telephone cord and modular plug is provided with this product. It is designed to be connected to a compatible modular jack that is also compliant. An RJ11 jack should normally be used for connecting to a single line and an RJ14 jack for two lines. See the installation instructions in the user's manual.

The Ringer Equivalence Number (REN) is used to determine how many devices you may connect to your telephone line and still have them ring when you are called. The REN for this product is encoded as the 6th and 7th characters following the US: in the product identifier (e.g., if ## is 03, the REN is 0.3). In most, but not all areas, the sum of all RENs should be five (5.0) or less. For more information, please contact your telephone service provider.

This equipment may not be used with Party Lines. If you have specially wired alarm dialing equipment connected to your telephone line, ensure the connection of this equipment does not disable your alarm equipment. If you have questions about what will disable alarm equipment, consult your telephone service provider or a qualified installer.

Appendix

FCC, ACTA and IC regulations (continued)

If this equipment is malfunctioning, it must be unplugged from the modular jack until the problem has been corrected. Repairs to this telephone equipment can only be made by the manufacturer or its authorized agents. For repair procedures, follow the instructions outlined under the Limited warranty.

If this equipment is causing harm to the telephone network, the telephone service provider may temporarily discontinue your telephone service. The telephone service provider is required to notify you before interrupting service. If advance notice is not practical, you will be notified as soon as possible. You will be given the opportunity to correct the problem and the telephone service provider is required to inform you of your right to file a complaint with the FCC. Your telephone service provider may make changes in its facilities, equipment, operation, or procedures that could affect the proper functioning of this product. The telephone service provider is required to notify you if such changes are planned.

If this product is equipped with a corded or cordless handset, it is hearing aid compatible.

If this product has memory dialing locations, you may choose to store emergency telephone numbers (e.g., police, fire, medical) in these locations. If you do store or test emergency numbers, please:

Remain on the line and briefly explain the reason for the call before hanging up.

Perform such activities in off-peak hours, such as early morning or late evening.

Industry Canada

Operation is subject to the following two conditions: (1) this device may not cause harmful interference, and (2) this device must accept any interference received, including interference that may cause undesired operation.

Privacy of communications may not be ensured when using this phone.

The term "IC:" before the certification/registration number only signifies that the Industry Canada technical specifications were met.

The Ringer Equivalence Number (REN) for this terminal equipment is 0.1. The REN is an indication of the maximum number of devices allowed to be connected to a telephone interface. The termination on an interface may consist of any combination of devices subject only to the requirement that the sum of the RENs of all the devices does not exceed five.

This product meets the applicable Industry Canada technical specifications.



Appendix



California Energy Commission battery charging testing instructions

This telephone is set up to comply with the energy-conserving standards right out of the box. These instructions are intended for California Energy Commission (CEC) compliance testing only.

When the CEC battery charging testing mode is activated, all headset functions, except battery charging, will be disabled.

To activate the CEC battery charging testing mode:

1. Before proceeding, make sure the headset battery is charged and the headset charger is connected to power.
2. Press **+VOLUME**, , **-VOLUME**, , **+VOLUME**, **-VOLUME** and .

When the headset successfully enters the CEC battery charging testing mode, the  light on the headset flashes slowly and alternately in red and blue. Press  and you hear "Not registered." Then put the headset in the headset charger for charging.

When the headset fails to enter this mode, repeat Step 1 to Step 2 above.

To deactivate the CEC battery charging testing mode:

1. Before proceeding, make sure the headset battery is charged.
Make sure the telephone base and headset charger are connected to power.
2. Register the headset back to the telephone base. See pages 26-27 for headset registration instructions.

Appendix

For C-UL compliance only

Mesures de sécurité importantes

Afin de réduire les risques d'incendie, de blessures corporelles ou d'électrocution, suivez toujours ces mesures préventives de base lorsque vous utilisez votre téléphone :

1. Lisez et comprenez bien toutes les instructions.
2. Observez toutes les instructions et mises en garde inscrites sur l'appareil.
3. Débranchez ce téléphone de la prise murale avant de le nettoyer. N'utilisez pas de nettoyeurs liquides ni en aérosol. N'utilisez qu'un chiffon doux et légèrement humecté.
4. N'utilisez pas ce produit près de l'eau, tel que près d'un bain, d'un lavabo, d'un évier de cuisine, d'un bac de lavage ou d'une piscine, ou dans un sous-sol humide ou sous la douche.
5. Ne déposez pas ce téléphone sur un chariot, support ou table chancelants. L'appareil pourrait tomber et être sérieusement endommagé.
6. Le boîtier de l'appareil est doté de fentes et d'ouvertures d'aération situées à l'arrière ou en dessous. Afin d'empêcher la surchauffe, ces ouvertures ne doivent pas être obstruées en plaçant l'appareil sur un lit, divan, tapis ou autre surface similaires. Ne placez pas cet appareil à proximité d'un élément de chauffage ni d'une plinthe électrique. De plus, ne l'installez pas dans une unité murale ou un cabinet fermé qui ne possède pas d'aération adéquate.
7. Ne faites fonctionner cet appareil qu'avec le type d'alimentation indiqué sur les étiquettes de l'appareil. Si vous ne connaissez pas le voltage de votre maison, consultez votre marchand ou votre fournisseur d'électricité.
8. Ne déposez rien sur le cordon d'alimentation. Installez cet appareil dans un endroit sécuritaire, là où personne ne pourra trébucher sur la ligne d'alimentation ni le cordon téléphonique modulaire.
9. N'insérez jamais d'objets à travers les fentes et ouvertures de cet appareil, car ils pourraient toucher à des points de tension dangereux ou court-circuiter des pièces, ce qui constituerait un risque d'incendie ou d'électrocution. N'échappez pas de liquides dans l'appareil.
10. Afin de réduire les risques d'électrocution, ne démontez pas l'appareil, mais apportez-le plutôt à un centre de service qualifié s'il doit être réparé. En enlevant le couvercle, vous vous exposez à des tensions dangereuses ou autres dangers similaires. Un remontage inadéquat peut être à l'origine d'une électrocution lors d'une utilisation ultérieure de l'appareil. Débranchez l'appareil avant de procéder au nettoyage. Utilisez un chiffon humide et doux.
11. Ne surchargez pas les prises de courant et les rallonges.
12. Débranchez cet appareil de la prise de courant et communiquez avec le département de service à la clientèle de VTech dans les cas suivants:
 - Lorsque le cordon d'alimentation est endommagé ou écorché.
 - Si du liquide a été échappé dans l'appareil.
 - Si l'appareil a été exposé à une source d'humidité telle que la pluie ou l'eau.
 - Si le produit ne fonctionne pas
 - normalement en respectant les instructions de fonctionnement. Réglez uniquement les commandes indiquées dans les instructions de fonctionnement. Les réglages incorrects des autres commandes pourraient provoquer un dommage qui pourrait exiger un travail exhaustif de la part d'un technicien autorisé afin de rétablir le fonctionnement normal de l'appareil.
 - Si le produit a été échappé et que le socle et/ou le combiné a été endommagé.
 - Si le produit affiche une nette diminution de sa performance.
13. Évitez d'utiliser un téléphone (autre qu'un sans fil) pendant un orage. Les éclairs peuvent être à l'origine d'une électrocution.

Appendix

For C-UL compliance only

14. N'utilisez pas le téléphone pour rapporter une fuite de gaz à proximité de la fuite. En certaines circonstances, une flammèche pourrait être provoquée lorsque l'adaptateur est branché à une prise de courant, ou lorsque le combiné est déposé sur le socle. Ceci est un événement commun associé à la fermeture d'un circuit électrique. L'utilisateur ne devrait pas brancher le téléphone à une prise de courant, et ne devrait pas déposer le combiné chargé sur le socle, si le téléphone se trouve à proximité d'un endroit comportant des concentrations de gaz inflammables, à moins que la ventilation soit adéquate. Une flammèche dans un tel endroit pourrait provoquer un incendie ou une explosion. De tels environnements peuvent comprendre: des endroits où l'on utilise de l'oxygène médical sans ventilation adéquate; des gaz industriels (dissolvants de nettoyage, des vapeurs d'essence, etc.); une fuite de gaz naturel, etc.
15. Ne placez que le combiné de votre téléphone près de votre oreille lorsqu'en mode de conversation.
16. Ces adaptateurs ont été conçus pour être orientés en position verticale ou montés au sol. Les broches ne sont pas conçues pour maintenir l'adaptateur en place si celui-ci est branché dans une prise au plafond ou sous une table/ armoire.

CONSERVEZ CES INSTRUCTIONS

Pile

- MISE EN GARDE : N'utilisez que la pile incluse.
- Ne jetez pas la pile au feu. Vérifiez les instructions spécifiques de mise aux rebus auprès des autorités locales.
- N'ouvrez pas et ne modifiez pas la pile. L'électrolyte qui s'en échapperait est corrosif et pourrait causer des brûlures ou des blessures aux yeux ou à la peau. L'électrolyte est toxique si avalé.
- Soyez prudents lorsque vous manipulez les piles afin d'éviter les courts-circuits provoqués par des matériaux conducteurs.
- Rechargez la pile incluse avec cet appareil, selon les instructions et limites spécifiées dans ce guide d'utilisation.

Stimulateurs cardiaques implantés dans l'organisme

Les simulateurs cardiaques (s'applique uniquement aux téléphones numériques sans fil):

L'organisme 'Wireless Technology Research, LLC (WTR)', une firme de recherche indépendante, a mené une évaluation pluridisciplinaire des interférences entre les téléphones sans fil portatifs et les stimulateurs cardiaques implantés dans l'organisme. Appuyée par l'Administration des aliments et drogues (FDA) des États-Unis, la firme WTR recommande aux médecins:

Avis aux détenteurs de stimulateurs cardiaques

- Ils doivent tenir le téléphone sans fil à une distance d'au moins six pouces du stimulateur cardiaque.
- Ils ne doivent PAS placer le téléphone sans fil directement sur le stimulateur cardiaque, tel que dans une poche de chemise, lorsque celui-ci est en marche.
- Ils doivent utiliser le téléphone sans fil en l'appuyant sur l'oreille qui se trouve dans la direction opposée au stimulateur cardiaque.

L'étude effectuée par l'organisme WRS n'a pas identifié de risque pour les détenteurs de simulateurs cardiaques causés par les gens qui utilisent un téléphone sans fil à proximité de ceux-ci.

Appendix

For C-UL compliance only

À propos des téléphones sans fil

- **Alimentation électrique:** Les mêmes caractéristiques qui constituent des avantages pour les téléphones sans fil affichent également des restrictions. Les appels téléphoniques sont transmis entre le combiné sans fil et le socle par le biais d'ondes radio ; il y a donc la possibilité que vos conversations téléphoniques sans fil soient interceptées par des équipements de réception radio se trouvant dans la portée du combiné sans fil. Pour cette raison, vous ne devez pas percevoir les communications téléphoniques sans fil comme étant aussi confidentielles.
- **Alimentation électrique:** Le socle de ce téléphone sans fil doit être branché à une prise électrique fonctionnelle. La prise électrique ne doit pas être contrôlée par un interrupteur mural. Les appels ne pourront pas être effectués du combiné sans fil si le socle est débranché ou mis hors tension ou si le courant est coupé.
- **Possibilité d'interférences aux téléviseurs:** Certains téléphones sans fil fonctionnent sur des fréquences pouvant causer des interférences aux téléviseurs et aux magnétoscopes. Pour réduire ou prévenir de telles interférences, ne placez pas le socle du téléphone sans fil près ou sur un téléviseur ou magnétoscope. S'il y a présence de parasites, il est conseillé d'éloigner le téléphone sans fil du téléviseur ou du magnétoscope afin de réduire possiblement les interférences.
- **Piles rechargeables:** Manipulez les piles avec soin afin de ne pas les court-circuiter avec des bagues, bracelets ou clés. Les piles ou le conducteur peut surchauffer et causer des blessures. Respectez la polarité adéquate entre la pile et le chargeur.
- **Les bloc-piles rechargeables à l'hydrure métallique de nickel:** Jetez ces blocs-piles de manière écologique et sécuritaire. Ne les incinerez pas et ne les percez pas. Tel que les autres piles de ce type, elles pourraient dégager une matière toxique qui peut causer des blessures corporelles si elles sont brûlées ou percées.

Appendix

Limited warranty

What does this limited warranty cover?

The manufacturer of this VTech Product warrants to the holder of a valid proof of purchase (“Consumer” or “you”) that the Product and all accessories provided in the sales package (“Product”) are free from defects in material and workmanship, pursuant to the following terms and conditions, when installed and used normally and in accordance with the Product operating instructions. This limited warranty extends only to the Consumer for Products purchased and used in the United States of America and Canada.

What will VTech do if the Product is not free from defects in materials and workmanship during the limited warranty period (“Materially Defective Product”)?

During the limited warranty period, VTech’s authorized service representative will repair or replace at VTech’s option, without charge, a Materially Defective Product. If we repair the Product, we may use new or refurbished replacement parts. If we choose to replace the Product, we may replace it with a new or refurbished Product of the same or similar design. We will retain defective parts, modules, or equipment. Repair or replacement of the Product, at VTech’s option, is your exclusive remedy. VTech will return the repaired or replacement Products to you in working condition. You should expect the repair or replacement to take approximately 30 days.

How long is the limited warranty period?

The limited warranty period for the Product extends for ONE (1) YEAR from the date of purchase. If VTech repairs or replaces a Materially Defective Product under the terms of this limited warranty, this limited warranty also applies to repaired or replacement Product for a period of either (a) 90 days from the date the repaired or replacement Product is shipped to you or (b) the time remaining on the original one-year warranty; whichever is longer.

What is not covered by this limited warranty?

This limited warranty does not cover:

1. Product that has been subjected to misuse, accident, shipping or other physical damage, improper installation, abnormal operation or handling, neglect, inundation, fire, water or other liquid intrusion; or
2. Product that has been damaged due to repair, alteration or modification by anyone other than an authorized service representative of VTech; or
3. Product to the extent that the problem experienced is caused by signal conditions, network reliability, or cable or antenna systems; or
4. Product to the extent that the problem is caused by use with non-VTech accessories; or
5. Product whose warranty/quality stickers, product serial number plates or electronic serial numbers have been removed, altered or rendered illegible; or
6. Product purchased, used, serviced, or shipped for repair from outside the United States of America or Canada, or used for commercial or institutional purposes (including but not limited to Products used for rental purposes); or
7. Product returned without a valid proof of purchase (see item 2 on the next page); or
8. Charges for installation or set up, adjustment of customer controls, and installation or repair of systems outside the unit.

Appendix

Limited warranty (continued)

How do you get warranty service?

To obtain warranty service, please visit our website at www.vtechphones.com or call 1 (800) 595-9511. In Canada, go to www.vtechcanada.com or dial 1 (800) 267-7377. NOTE: Before calling for service, please review the user's manual - a check of the Product's controls and features may save you a service call.

Except as provided by applicable law, you assume the risk of loss or damage during transit and transportation and are responsible for delivery or handling charges incurred in the transport of the Product(s) to the service location. VTech will return repaired or replaced Product under this limited warranty. Transportation, delivery or handling charges are prepaid. VTech assumes no risk for damage or loss of the Product in transit. If the Product failure is not covered by this limited warranty, or proof of purchase does not meet the terms of this limited warranty, VTech will notify you and will request that you authorize the cost of repair prior to any further repair activity. You must pay for the cost of repair and return shipping costs for the repair of Products that are not covered by this limited warranty.

What must you return with the Product to get warranty service?

1. Return the entire original package and contents including the Product to the VTech service location along with a description of the malfunction or difficulty; and
2. Include a "valid proof of purchase" (sales receipt) identifying the Product purchased (Product model) and the date of purchase or receipt; and
3. Provide your name, complete and correct mailing address, and telephone number.

Other limitations

This limited warranty is the complete and exclusive agreement between you and VTech. It supersedes all other written or oral communications related to this Product. VTech provides no other warranties for this Product. The limited warranty exclusively describes all of VTech's responsibilities regarding the Product. There are no other express warranties. No one is authorized to make modifications to this limited warranty and you should not rely on any such modification.

State/Provincial Law Rights: This limited warranty gives you specific legal rights, and you may also have other rights, which vary from state to state or province to province.

Limitations: Implied warranties, including those of fitness for a particular purpose and merchantability (an unwritten warranty that the Product is fit for ordinary use) are limited to one year from the date of purchase. Some states/provinces do not allow limitations on how long an implied warranty lasts, so the above limitation may not apply to you. In no event shall VTech be liable for any indirect, special, incidental, consequential, or similar damages (including, but not limited to lost profits or revenue, inability to use the Product or other associated equipment, the cost of substitute equipment, and claims by third parties) resulting from the use of this Product. Some states/provinces do not allow the exclusion or limitation of incidental or consequential damages, so the above limitation or exclusion may not apply to you.

Please retain your original sales receipt as proof of purchase.

Appendix

Technical specifications

Frequency control	Crystal controlled PLL synthesizer
-------------------	------------------------------------

Transmit frequency	Handset: 1921.536-1928.448 MHz Telephone base: 1921.536-1928.448 MHz Headset: 1921.536-1928.448 MHz
--------------------	---

Channels	5
----------	---

Nominal effective range	Maximum power allowed by FCC and IC. Actual operating range may vary according to environmental conditions at the time of use.
-------------------------	--

Power requirements	Handset: 2.4V Ni-MH battery Telephone base: 6V DC @ 400mA Handset charger: 6V AC @300mA Headset charger: 6V DC @ 400mA
--------------------	---

Memory	Handset directory: 200 memory locations; up to 30 digits and 15 characters Four download directories: 1,500 memory locations (each); up to 30 digits and 15 characters Handset caller ID log: 50 memory locations; up to 15 digits and 15 characters
--------	---

Index

A

- Add a cell phone 25
- Add a handset 104
- Add a headset 27_105
- Alphabetical search 71
- Announcement 83
- Answer a cell call 52
- Answer a cell call while on a home call 53
- Answer a home call 50
- Answer a home call while on a cell call 53
- Answer an incoming call during a PTT call 68
- Answering a PTT call 67
- Answering system and voicemail 89
- Answering system setup 85
- Answer on/off 82
- Assign a speed dial slot 74

B

- Battery 4_5_7
- Bluetooth connection from Idle mode 32
- Bluetooth glossary 24
- Bluetooth headset 27_50
- Bluetooth setup 25

C

- Caller ID 76
- Caller ID history 77
- Caller ID log 77
- Call screening 85_90
- Call waiting on the cell line 52
- Call waiting on the home line 51
- Cell area code 48
- Cell call 52
- Cell phone - download directory 33
- Cell phone voicemail 53
- Chain dialing 58
- Change a one-to-one PTT to intercom 67
- Change PIN 36
- Charging 5_6
- CID time synchronization 44

- Conference home and cell calls 54
- Connect an active device 29
- Create a new directory entry 70

D

- Date 39
- Delete a directory entry 73
- Delete a redial entry 60
- Delete a speed dial entry 75
- Delete from the caller ID log 81
- Delete messages 91_92_93
- Delete the announcement 84
- Deregister handsets 106
- Devices connection 29
- Dial a caller ID log entry 79
- Dial a directory entry 72
- Dial a redial entry 59
- Dial a speed dial entry 74
- Dialing options 79
- Dial mode 45
- Directory 33_69
- Disconnect an active device 29
- Display alerts 41
- Display screen messages 96
- Download directory 33
- Download fail 43
- DSL filter 3

E

- Earbud installation 8
- Ear hook installation 9_10_11
- Edit a directory entry 72
- Edit the type of a directory entry 73
- End a cell call 52
- End a home call 50
- End a PTT call 68
- Equalizer 57
- Expand your telephone system 104

F

- FCC, ACTA and IC regulations 123
- Find handset 56
- Flash 51_52

Index

- G**
 - Glossary 24
- H**
 - Handset icons 102
 - Handset layout 17
 - Handset lights 101
 - Handset locator 56
 - Handset main menu 21
 - Handset ringer volume 37
 - Handset speakerphone 55
 - Head band installation 12_13
 - Headset charger installation 6
 - Headset charging 6
 - Headset layout 20
 - Headset listening volume 55
 - Headset ringer volume 37
 - Hold 56
 - Hold a call and intercom 63
 - Home area code 47
- I**
 - Icons 101_102
 - Important safety instructions 120
 - Indicators 101_103
 - Installation 2_3_4_6_8_9_12_14_15
 - Intercom 61
 - Interruption to directory download 35
- K**
 - Key tone 45
- L**
 - Language 40
 - LCD language 40
 - Lights 101_103
 - Limited warranty 129
- M**
 - Maintenance 121
 - Make a call using speed dial 74
 - Make a cell call 52
 - Make a home call 50
 - Make an outgoing call during a PTT call 68
 - Memory match 77
 - Memos 93
 - Message alert tone 88
 - Message capacity 90
 - Message playback 91_92
 - Message window displays 94
 - Missed calls 41
 - Mute 55
- N**
 - No home line 43
 - Number of rings 86
- O**
 - Operating range 121
- P**
 - Paging 56
 - Pair and connect a Bluetooth headset 27
 - Pair and connect a cell phone 25
 - Parts checklist 1
 - Play memos 93
 - Play messages 91_92
 - Play the announcement 83
 - Power off the headset 6
 - Power on the headset 6
 - Redial a home call 50
 - PTT 64
 - PTT on/off 64
 - PTT to all handsets 66
 - PTT to a single handset 65
 - Pulse dialing 45_56
 - Push-to-talk 64
- R**
 - Reassign a speed dial slot 74
 - Record an announcement 83
 - Recording time setting 88
 - Record memos 93
 - Redial list 59
 - Register a handset 104
 - Register a headset 105
 - Remote access 95
 - Remote access code 87
 - Remove a device 30
 - Remove a downloaded directory 73
 - Rename a device 31

Index

Repeat messages 91_92
Replace a handset 106
Replace a headset 106
Replace an active device 32
Reset download fail indication 43
Reset the missed call indicator 41
Reset the voicemail indicators 42
Review the caller ID log 78
Review the directory 71
Review the redial list 59
Ringer mute 55
Ringer tone 38
Ringer volume 37_49

S

Safety instructions 120
Save a caller ID log entry to the directory 80
Save a redial entry to the directory 60
Search for a contact 71
Set date/time 39
Share an outside call 61
Silence the ringer 55
Skip messages 91_92
Speakerphone 55
Speed dial 74
Stop messages 91_92
Swap 52

T

Technical specifications 131
Telephone base installation 3
Telephone base lights 101
Telephone base ringer volume 49
Temporary tone dialing 56
Time 39
Transfer a call 57_63
Transfer a call from a handset to a headset 51
Troubleshooting 107
Turn on or off the answering system 82

U

Using a Bluetooth headset 50

V

View directory download information 35
Voice announce caller ID 46
Voice language 40
Voicemail 42_53_89
Voicemail indicators 42
Volume 37_45_49_55_91_92

W

Wall mounting 14
Warranty 129
Website 47

The *Bluetooth*[®] word mark and logos are owned by Bluetooth SIG, Inc. and any use of such marks by VTech Holdings Limited is under license. VTech Holdings Limited is a member of Bluetooth SIG, Inc. Other trademarks and trade names are those of their respective owners.



Designed to fit your home.
And your life.

VTech Communications, Inc.

A member of THE VTECH GROUP OF COMPANIES.

VTech is a registered trademark of VTech Holdings Limited.

Specifications are subject to change without notice.

Copyright © 2014 for VTech Communications, Inc.

All rights reserved. 05/14. DS6472_CIB_V3.0

Document order number: 91-007078-030-100

